

# *UC-2000 LASER CONTROLLER*



---

**operator's  
manual**

---



**An Excel Technology Company**

4600 Campus Place  
Mukilteo, WA 98275  
1.800.SYNRAD1  
*tel* 1.425.349.3500  
*fax* 1.425.349.3667  
*e-mail* [synrad@synrad.com](mailto:synrad@synrad.com)  
[www.synrad.com](http://www.synrad.com)



# *UC-2000*

## *LASER CONTROLLER*

### **UC-2000 Universal Laser Controller Operator's Manual**

Version 2.1

July 2009

Part number 900-18128-02



**An Excel Technology Company**

4600 Campus Place  
Mukilteo, WA 98275  
1.800.SYNRAD1  
*tel* 1.425.349.3500  
*fax* 1.425.349.3667  
*e-mail* [synrad@synrad.com](mailto:synrad@synrad.com)  
[www.synrad.com](http://www.synrad.com)



# table of contents

## Laser Safety

Hazard information.....	1
Terms.....	1
General hazards .....	1
Label locations .....	4
Agency compliance.....	5
Federal Communications Commission requirements .....	5
European Union requirements .....	5
Declaration of Conformity.....	8

## Getting Started 1

Inventory .....	1-2
Contents description .....	1-2
Introduction.....	1-3
Features .....	1-3
Mounting.....	1-4
Standard model.....	1-4
Panel mount model.....	1-4
Connecting .....	1-5
Power cable.....	1-5
Control cable .....	1-5

## Operation 2

Controls and indicators.....	2-2
Control panel.....	2-2
Rear panel.....	2-3
LCD display .....	2-4
Initial start-up .....	2-5
Setup .....	2-6
Setting PWM frequency .....	2-6
Setting gate logic .....	2-7
Setting max PWM percentage .....	2-8
Setting lase on power-up .....	2-8
Setting option 1-3 .....	2-10
Save and exit .....	2-10
Factory default settings .....	2-10
UC-2000 control.....	2-11
Local control.....	2-11

# table of contents

## Operation 2 (cont.)

REMOTE (RS-232) control.....	2-12
Laser control.....	2-14
Operating modes.....	2-14
Gate input.....	2-18

## Technical Reference 3

Control signals.....	3-2
Tickle pulse.....	3-2
Pulse Width Modulation (PWM).....	3-2
Command signal.....	3-3
External control.....	3-5
Gate input.....	3-5
Analog control.....	3-7
Closed loop control.....	3-9
REMOTE (RS-232) control.....	3-11
Connector pinouts.....	3-17
Laser connector.....	3-17
Closed loop (C/L) connector.....	3-17
General specifications.....	3-18
UC-2000 package outlines.....	3-19

## Troubleshooting 4

Troubleshooting.....	4-2
----------------------	-----

## Appendix A

Closed Loop Stabilization Kit.....	A-2
Introduction.....	A-2
Safety precautions.....	A-2
Connecting.....	A-3
Operation.....	A-4
Closed loop specifications.....	A-4

## Index

# table of contents

## List of Figures

Figure 1	UC-2000 CE label location .....	4
Figure 2	European compliance mark .....	6
Figure 2-1	Control panel .....	2-2
Figure 2-2	Rear panel.....	2-3
Figure 2-3	Firmware screen.....	2-4
Figure 2-4	Start-up screen .....	2-4
Figure 2-5	Setup screens .....	2-6
Figure 2-6	REMOTE mode.....	2-13
Figure 2-7	MANUAL mode.....	2-15
Figure 2-8	ANC mode.....	2-15
Figure 2-9	ANV mode.....	2-16
Figure 2-10	MAN. CLOSED mode.....	2-17
Figure 2-11	ANV CLOSED mode.....	2-17
Figure 3-1	Tickle pulse parameters .....	3-2
Figure 3-2	Representative optical output waveforms .....	3-3
Figure 3-3	Command signal parameters .....	3-4
Figure 3-4	UC-2000 input/output signal relationships .....	3-5
Figure 3-5	Physical layout of RS-232 Serial Port connector.....	3-11
Figure 3-6	RS-232 cable wiring diagram .....	3-12
Figure 3-7	UC-2000 package outline dimensions .....	3-19
Figure 3-8	UC-2000 panel mount package outline dimensions.....	3-20
Figure A-1	Typical closed loop setup .....	A-3

# table of contents

## List of Tables

Table 1	European Union Directives .....	6
Table 1-1	Shipping box contents.....	1-2
Table 2-1	Factory default settings.....	2-10
Table 3-1	Command signal output specifications.....	3-4
Table 3-2	Gate input specifications .....	3-6
Table 3-3	Analog current specifications.....	3-7
Table 3-4	Analog voltage specifications.....	3-8
Table 3-5	Analog voltage closed loop specifications.....	3-10
Table 3-6	UC-2000 RS-232 pin assignments .....	3-12
Table 3-7	Host serial port configuration.....	3-13
Table 3-8	REMOTE Mode commands .....	3-14
Table 3-9	REMOTE Lase commands .....	3-14
Table 3-10	REMOTE Setup commands .....	3-15
Table 3-11	REMOTE PWM (or SET) percentage command....	3-15
Table 3-12	REMOTE Status command .....	3-16
Table 3-13	Laser connector pinouts.....	3-17
Table 3-14	C/L connector pinouts.....	3-17
Table 3-15	UC-2000 general specifications.....	3-18
Table A-1	Closed loop general specifications .....	A-4

# **Trademark/copyright information**

SYNRAD, Firestar, and Power Wizard are registered trademarks of SYNRAD, Inc.  
Evolution is a trademark of SYNRAD, Inc.

All other trademarks or registered trademarks are the property of their respective owners.

© 2005, 2009 by SYNRAD, Inc.  
All rights reserved.

## Warranty information

This is to certify that UC-2000 Universal Laser Controllers are guaranteed by SYNRAD, Inc. to be free of all defects in materials and workmanship for a period of one year from the date of purchase. This warranty does not apply to any defect caused by negligence, misuse (including environmental factors), accident, alteration, or improper maintenance.

If, within one year from the date of purchase, any part of the UC-2000 Universal Laser Controller should fail to operate, contact the SYNRAD Customer Service department at 1.800.SYNRAD1 (outside the U.S. call 1.425.349.3500) and report the problem. When calling for support, please be prepared to provide the date of purchase, model number and serial number of the unit, and a brief description of the problem. When returning a unit for service, a Return Authorization (RA) number is required; this number must be clearly marked on the outside of the shipping container in order for the unit to be properly processed. If replacement parts are sent to you, then you are required to send the failed parts back to SYNRAD for evaluation unless otherwise instructed.

If the UC-2000 Universal Laser Controller fails within the first 45 days after purchase, SYNRAD, Inc. will pay all shipping charges to and from SYNRAD when shipped as specified by SYNRAD Customer Service. After the first 45 days, SYNRAD will continue to pay for the costs of shipping the repaired unit or replacement parts back to the customer from SYNRAD. The customer, however, will be responsible for shipping charges incurred when sending the failed unit or parts back to SYNRAD or a SYNRAD Authorized Distributor. In order to maintain your product warranty and to ensure the safe and efficient operation of your UC-2000 Universal Laser Controller, only authorized SYNRAD replacement parts can be used. This warranty is void if any parts other than those provided by SYNRAD, Inc. are used.

SYNRAD, Inc. and SYNRAD Authorized Distributors have the sole authority to make warranty statements regarding SYNRAD products. SYNRAD, Inc. and its Authorized Distributors neither assumes nor authorizes any representative or other person to assume for us any other warranties in connection with the sale, service, or shipment of our products. SYNRAD, Inc. reserves the right to make changes and improvements in the design of our products at any time without incurring any obligation to make equivalent changes in products previously manufactured or shipped. Buyer agrees to hold SYNRAD harmless from any and all damages, costs, and expenses relating to any claim arising from the design, manufacture, or use of the product, or arising from a claim that such product furnished Buyer by SYNRAD, or the use thereof, infringes upon any Patent, foreign or domestic.

# Contact information

## Worldwide headquarters

SYNRAD's worldwide headquarters are located in Mukilteo, Washington, U.S.A. Our mailing address is:

SYNRAD, Inc.  
4600 Campus Place  
Mukilteo, WA 98275  
U.S.A.

Phone us at: 1.800.SYNRAD1 (1.800.796.7231)  
Outside the U.S.: 1.425.349.3500  
Fax: 1.425.349.3667  
Email: synrad@synrad.com

## Sales and Applications

SYNRAD's Regional Sales Managers work with customers to identify and develop the best CO<sub>2</sub> laser solution for a given application. Because they are familiar with you and your laser application, use them as a first point of contact when questions arise. Our Regional Sales Managers also answer technical support questions regarding the installation, use, troubleshooting, and maintenance of our products and can provide reference materials including Outline & Mounting drawings, Operator's Manuals, Technical Bulletins, and Application Newsletters. In addition, your Regional Sales Manager serves as the liaison between you and our Applications Lab in processing material samples per your specifications. To speak to the Regional Sales Manager in your area, call SYNRAD at 1.800.SYNRAD1.

## Customer Service

For assistance with order or delivery status, or to obtain a Return Authorization (RA) number, contact SYNRAD at 1.800.SYNRAD1 and ask to speak to a Customer Service representative.

## European headquarters

SYNRAD's European subsidiary, Excel Technology Europe GmbH, covers Austria, Germany, Switzerland, and Italy. Contact Excel Technology at:

Excel Technology Europe GmbH  
Münchner Str. 2a  
D-82152 Planegg  
Germany

Phone: 49 89 891 462-0  
Fax: 49 89 891 462-69

This page intentionally left blank

# laser safety

## Hazard information

Hazard information includes terms, symbols, and instructions used in this manual or on the equipment to alert both operating and service personnel to the recommended precautions in the care, use, and handling of Class IV laser equipment.

### Terms

Certain terms are used throughout this manual or on the equipment labels. Please familiarize yourself with their definitions and significance.

 **Danger:** Imminent hazards which, if not avoided, will result in death or serious injury.

 **Warning:** Potential hazards which, if not avoided, could result in death or serious injury.

 **Caution:** Potential hazards or unsafe practices which, if not avoided, may result in minor or moderate injury.

**Caution:** Potential hazards or unsafe practices which, if not avoided, may result in product damage.

**Note:** Points of particular interest for more efficient or convenient equipment operation; additional information or explanation concerning the subject under discussion.

### General hazards

Following are descriptions of general hazards and unsafe practices that could result in death, severe injury, or product damage when working with or around CO<sub>2</sub> lasers. Specific warnings and cautions not appearing in this section are found in your laser's *Operator's Manual*.

 **Danger**  
serious  
personal  
injury

Direct or diffuse laser radiation can inflict severe corneal injuries. Always wear eye protection when in the same area as an exposed laser beam. Eyewear protects against scattered energy and is not intended to protect against direct viewing of the beam or reflections from metallic surfaces. Protective eyewear that blocks 10.6 μm wavelength CO<sub>2</sub> laser radiation is available from SYNRAD.

# laser safety

## Hazard information

### **Warning**

serious  
personal  
injury

Enclose the beam path whenever possible. Direct or diffuse laser radiation can seriously burn human or animal tissue, which may cause permanent damage.

U.S. customers should refer to and follow laser safety precautions in ANSI Z136.1-2007, *Safe Use of Lasers*. Procedures listed in this Standard include the appointment of a Laser Safety Officer (LSO), operation of the product in an area of limited access by trained personnel, servicing of equipment only by trained and authorized personnel, and posting of signs warning of the potential hazards. European customers should appoint a Laser Safety Officer (LSO) who should refer to and follow laser safety precautions described in EN 60825-1, 2007—*Safety of Laser Products*.

Materials processing with a laser can generate air contaminants such as vapors, fumes, and/or particles that may be noxious, toxic, or even fatal. Material Safety Data Sheets (MSDS) for materials being processed should be thoroughly evaluated and the adequacy of provisions for fume extraction, filtering, and venting should be carefully considered. Review the following references for further information on exposure criteria:

ANSI Z136.1-2007, *Safe Use of Lasers*, section 7.3.

U.S. Government's *Code of Federal Regulations*: 29 CFR 1910, Subpart Z.

*Threshold Limit Values* (TLV's) published by the American Conference of Governmental Industrial Hygienists (ACGIH).

It may be necessary to consult with local governmental agencies regarding restrictions on the venting of processing vapors.

# laser safety

## Hazard information

### **Warning**

serious  
personal  
injury

The use of controls or adjustments or performance of procedures other than those specified herein may result in hazardous radiation exposure.

### Other hazards

The following hazards are typical for this product family when incorporated for intended use: (A) risk of injury when lifting or moving the unit; (B) risk of exposure to hazardous laser energy through unauthorized removal of access panels, doors, or protective barriers; (C) risk of exposure to hazardous laser energy and injury due to failure of personnel to use proper eye protection or failure to adhere to applicable laser safety procedures; (D) generation of hazardous air contaminants that may be noxious, toxic, or even fatal.

### Disposal

This product contains components that are considered hazardous industrial waste. If a situation occurs where the unit is rendered non-functional and cannot be repaired, it may be returned to SYNRAD, Inc. who, for a fee, will ensure adequate disassembly, recycling, and/or disposal of the product.

### Additional laser safety information

The SYNRAD web site (<http://www.synrad.com/LaserFacts/lasersafety.html>) contains an on-line laser safety handbook that provides information on (1) Laser Safety Standards for OEM's/System Integrators; (2) Laser Safety Standards for End Users; (3) References and Sources; and (4) Assistance with Requirements.

In addition, the Occupational Safety and Health Administration (OSHA) has an online Technical Manual located at [http://www.osha.gov/dts/osta/otm/otm\\_iii/otm\\_iii\\_6.html](http://www.osha.gov/dts/osta/otm/otm_iii/otm_iii_6.html). Section III, Chapter 6 and Appendix III are good resources for laser safety information.

Another excellent laser safety resource is the Laser Institute of America (LIA). Their comprehensive web site is located at <http://www.laserinstitute.org>.

# laser safety

## Label locations

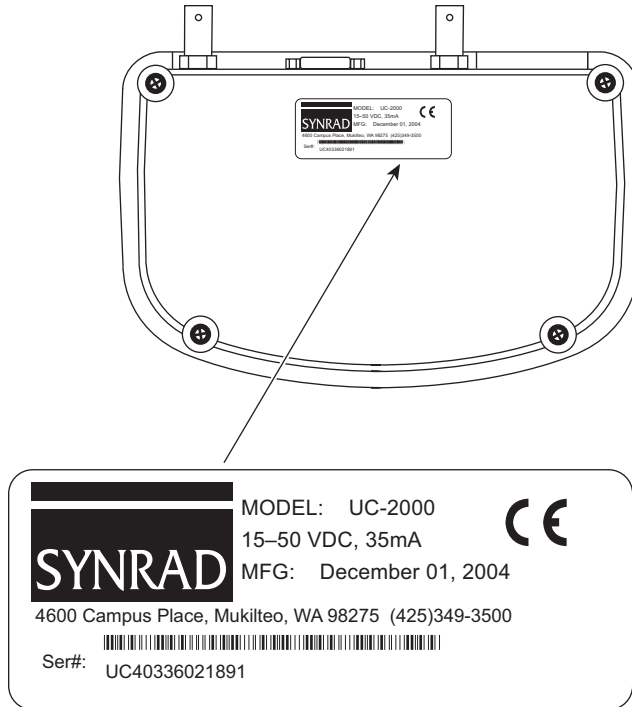

**Figure 1** UC-2000 CE label location

# laser safety

## Agency compliance

The UC-2000 Universal Laser Controller has been tested and certified to comply with certain United States and European Union (EU) Directives. These Directives impose product performance requirements related to electromagnetic compatibility (EMC) and product safety characteristics for laser products. The associated Directives and specific provisions to which systems containing the UC-2000 Universal Laser Controller must comply are identified and described in the following paragraphs.

## Federal Communications Commission requirements

The United States Communication Act of 1934 vested the Federal Communications Commission (FCC) with the authority to regulate equipment that emits electromagnetic radiation in the radio frequency spectrum. The purpose of the Communication Act is to prevent harmful electromagnetic interference from affecting radio communication services.

### FCC information to the user

NOTE: This equipment has been tested and found to comply with the limits for a Class A digital device pursuant to Part 15 of the FCC Rules. These limits are designed to provide reasonable protection against harmful interference when the equipment is operated in a commercial environment. This equipment generates, uses, and can radiate radio frequency energy and, if not installed and used in accordance with the instruction manual, may cause harmful interference to radio communications. Operation of this equipment in a residential area is likely to cause harmful interference in which case the user will be required to correct the interference at his own expense.

### FCC caution to the user

The Federal Communications Commission warns the user that changes or modifications of the unit not expressly approved by the party responsible for compliance could void the user's authority to operate the equipment.

## European Union requirements

### Electromagnetic interference standards

The European Union's Electromagnetic Compatibility (EMC) Directive 2004/1086/EC is the sole Directive developed to address electromagnetic interference (EMI) issues in electronic equipment. In particular, the Directive calls out European Norm (EN) documents that define the emission and immunity standards for specific product categories. For the UC-2000 Universal Laser Controller, EN 55011 defines radiated RF emission limits while the generic Standard EN 50082-2 defines immunity requirements published by the International Electromechanical Commission (IEC).

# laser safety

## Agency compliance

UC-2000 Universal Laser Controllers have demonstrated performance characteristics that have met or exceeded the requirements of the EMC directive 2004/108/EC.

Table 1 contains a summary of EU performance requirements pertaining to the UC-2000 Universal Laser Controller.

**Table 1** European Union Directives

### Applicable Standards/Norms

2004/108/EC	Electromagnetic Compatibility Directive
EN 55011:1998	Radiated and Conducted Emissions
EN 50082-2:1997	RF Electromagnetic Immunity
ENV 50204:1995	RF Electromagnetic Fields Immunity
EN 61000-4-2:1995+A1:1998	Electrostatic Discharge Immunity
EN 61000-4-3:1999	RF Electromagnetic Fields Immunity
EN 61000-4-4:1995	Electrical Fast Transient/Burst Immunity
EN 61000-4-6:1996	Conducted RF Disturbances Immunity

After a product has met the requirements of all applicable EU directives, the product can bear the official compliance mark of the European Union as shown in Figure 2.



**Figure 2** European compliance mark

# laser safety

## **Agency compliance**

### RoHS compliance

UC-2000 Universal Laser Controllers meet the requirements of the European Parliament and Council Directive 2002/95/EC on the Restriction of the Use of Certain Hazardous Substances in Electrical and Electronic Equipment, as amended by Decision 2005/618/EC establishing maximum concentration values for certain hazardous substances in electrical and electronic equipment.

# laser safety

## Declaration of Conformity

### Declaration of Conformity

in accordance with ISO / IEC 17050-2:2004

We,

**Manufacturer's Name:** SYNRAD, Inc.

**Manufacturer's Address:** 4600 Campus Place  
Mukilteo, WA 98275  
U.S.A.

hereby declare under our sole responsibility that the following equipment:

**Product Name:** UC-2000 Universal Laser Controller

**Model Number:** UC-2000

conforms to the following Directive(s) and Standard(s):

**Applicable Directive(s):** 2004/108/EC Electromagnetic Compatibility Directive  
2002/95/EC RoHS Directive (amended by 2005/618/EC)

**Applicable Standard(s):** EN 55011:1998 Conducted and Radiated Emissions  
EN 50082-2:1997 RF Electromagnetic Immunity  
ENV 50204:1995 RF Electromagnetic Fields Immunity  
EN 61000-4-2:1995  
+A1:1998 Electrostatic Discharge Immunity  
EN 61000-4-3:1999 RF Electromagnetic Fields Immunity  
EN 61000-4-4:1995 Electrical Fast Transient/Burst Immunity  
EN 61000-4-6:1996 Conducted RF Disturbances Immunity

**Corporate Officer:**



Dave Clarke, President of SYNRAD, Inc.

**European Contact:**

Excel Technology Europe GmbH  
Münchner Str. 2a  
D-82152 Planegg  
Germany

Dated 01 July 2009

# getting started

Use information in this section to prepare your UC-2000 Universal Laser Controller for operation. The order of information presented in this section is the same as the order of tasks that you will need to perform. The best way to get the UC-2000 ready for operation is to start at *Inventory* and work your way through *Connecting*.

This section contains the following information:

- Inventory – lists all components shipped with your UC-2000 Controller.
- Introduction – describes the history of the UC-2000.
- Mounting – describes UC-2000 mounting methods.
- Connecting – explains how to connect the UC-2000 to your laser.

# getting started

## Inventory

Table 1-1 lists all items packaged with your UC-2000 Controller.

**Table 1-1** Shipping box contents

<b>Shipping Box Contents</b>	<b>Qty</b>
SYNRAD UC-2000 Universal Laser Controller .....	1
UC-2000 Operator's Manual .....	1
Power/Control Cable .....	1
Wall Plug Transformer .....	1
BNC to BNC Control Cable .....	1
BNC Tee .....	1

## Contents description

A description of each item listed in Table 1-1 follows:

SYNRAD UC-2000 Universal Laser Controller – outputs laser Command signals and accepts external control and gating signals.

*UC-2000 Laser Controller Operator's Manual* – presents setup, operation, and technical information.

Power/Control Cable – provides DC power to the UC-2000 and outputs tickle/Command signals to the laser.

Wall Plug Transformer – provides 24 VDC to the UC-2000 Controller from a 100–240 VAC, 50–60 Hz wall plug outlet.

BNC to BNC Control Cable – use with BNC Tee to connect *Power/Control Cable* to dual-tube lasers.

BNC Tee – for connecting control cables to dual-tube lasers with two PWM control inputs.

# getting started

## Introduction

The UC-2000 Universal Laser Controller is SYNRAD's second-generation laser controller, a product which has evolved from years of experience with UC-1000 Controllers currently being used in hundreds of applications at customer sites throughout the world.

## Features

UC-2000 features include:

- Real-time LCD display of operating mode and PWM power settings
- Control knob sets laser power in 0.5% or 5% increments
- Built-in Laser indicator
- Remote analog voltage or analog current power control
- DB9 serial connection allows UC-2000 control through an RS-232 serial port from a host computer or PLC
- Real-time display of power setpoint and actual closed loop power regulation
- Available in an optional panel mount design

# getting started

## Mounting

### Standard model

The UC-2000 Universal Laser Controller's rubber feet are designed for shelf or table-top mounting. If your application requires the UC-2000 to be securely fastened to a shelf or rack, perform the following steps:

- 1 Remove at least two of the four 6–32 Phillips head screws holding the UC-2000's rubber feet to the chassis.
- 2 Drill holes into your mounting surface so that hole positions correspond to the UC-2000's feet locations. Refer *UC-2000 package outlines* in the Technical Reference chapter for dimensions.
- 3 Position the UC-2000 and its rubber feet over the mounting holes and replace the 6–32 screws removed in Step 1.

**Note:** If you must replace the standard mounting screws, the screw's additional length must be no longer than the thickness of the mount to prevent damage to the UC-2000's case or internal components.

### Panel mount model

To mount the UC-2000 panel mount version, perform the following steps:

- 1 Refer *UC-2000 package outlines* in the Technical Reference chapter for dimensions and then cut out a rectangle, measuring approximately 7.13" × 3.25" (18.1 cm × 8.3 cm), on your rack mount filler panel or cabinet housing.
- 2 Use the mounting hole dimensions shown in the *UC-2000 package outlines* panel mount drawing to drill and tap four 6–32 (M3.5×0.6) screw holes in the rack mount panel or cabinet housing.
- 3 Insert the panel mount UC-2000 Controller into the rectangular cutout and secure with four 6–32 or M3.5 screws.

# getting started

## Connecting

Refer to *Controls and indicators* in the Operation chapter for illustrations showing the placement and function of connections to the UC-2000 Controller.

### Power cable

To connect power to the UC-2000, perform the following steps:

- 1 Locate the *Power/Control* cable in the shipping kit.
- 2 Connect the 4-pin mini-DIN connector to the *Laser* connector on the rear of the UC-2000.
- 3 For Series 48 lasers, connect the miniature DC power plug on the other end of the *Power/Control* cable to the laser's side-mounted auxiliary power connector.

For Evolution or Firestar lasers, connect the miniature DC power plug on the end of the *Power/Control* cable to the miniature connector on the cable from the *Wall Plug Transformer*. Plug the compact transformer into any 100–240 VAC, 50–60 Hz outlet.

For other laser types, power the UC-2000 from any 15–50 VDC source capable of supplying 35 milliamperes (mA) of current. If you choose to supply DC voltage from an alternate power source, ensure that connector polarity to the miniature DC power plug is correct: the tip or inner sleeve polarity is positive (+); the ring or outer sleeve polarity is negative (–).

### Control cable

Attach the *Power/Control* cable to your laser according to its type:

#### Series 48-1, 48-2 laser:

Attach the BNC connector from the *Power/Control* cable to the laser's control input, labeled *CTRL*, located on the rear of the laser.

#### Series 48-5 laser:

Attach one end of the BNC–BNC coaxial control cable to the BNC connector from the *Power/Control* cable using the supplied BNC Tee. Attach the open end of the BNC Tee to one of the control inputs, *CTRL1* or *CTRL2*, located on the rear of the laser. Connect the other end of the BNC–BNC cable to the other control input.

# getting started

## Connecting

### Evolution™ 100/125 laser:

Attach the BNC connector from the *Power/Control* cable to the control input, labeled *Control In*, located on the front or rear panel of the RF-3000 RF power supply.

### Evolution™ 200/240 laser:

Attach the BNC connector from the *Power/Control* cable to the BNC Tee connecting the *Set 1* and *Set 2* control inputs, labeled *Control In*, located on the front or rear panel of the RF-3000 RF power supplies.

### Firestar® v30, v40, ti60, t70i, f100, f201 laser:

Attach the BNC connector from the *Power/Control* cable to the BNC connector on the *Quick Start Plug* (or customer-supplied DB-15 connector) attached to the *User I/O* port on the rear panel of the laser.

### Firestar® t60, t80, t100 laser:

Attach the BNC connector from the *Power/Control* cable to the BNC connector on the *Quick Start Plug* (or customer-supplied DB-15 connector) attached to the *User I/O* port on the rear panel of the RF power supply.

### Firestar® f200, f400 laser:

Attach one end of the BNC–BNC coaxial control cable to the BNC connector from the *Power/Control* cable using the supplied BNC Tee. Attach the open end of the BNC Tee to one of the *Quick Start Plugs* (or customer-supplied DB-15 connector) attached to the *User I/O* port on the rear panel of the laser. Connect the other end of the BNC–BNC cable to the other *Quick Start Plug* (or customer-supplied DB-15 connector).

The connections you have just completed are sufficient for manual operation and testing of the UC-2000 Controller. Refer to *Initial start-up* in the Operation chapter for start-up procedures.

See *UC-2000 control* and *Laser control* in the Operation chapter for detailed information regarding UC-2000 operation and the various options for PWM laser control. *External control* in the Technical Reference chapter describes how to connect externally-generated control signals to the UC-2000 Controller.

# operation

Use information in this section to familiarize yourself with UC-2000 controls and indicators and to begin operation.

This section contains the following information:

- Controls and indicators – displays and describes UC-2000 controls, indicators, and connections.
- Initial start-up – explains how to operate the UC-2000 Controller.
- Setup – describes how to set UC-2000 operating parameters.
- UC-2000 control – describes local and REMOTE control of the UC-2000.
- Laser control – describes each of the UC-2000's PWM control methods and explains the gating function.

# operation

## Controls and indicators

### Control panel

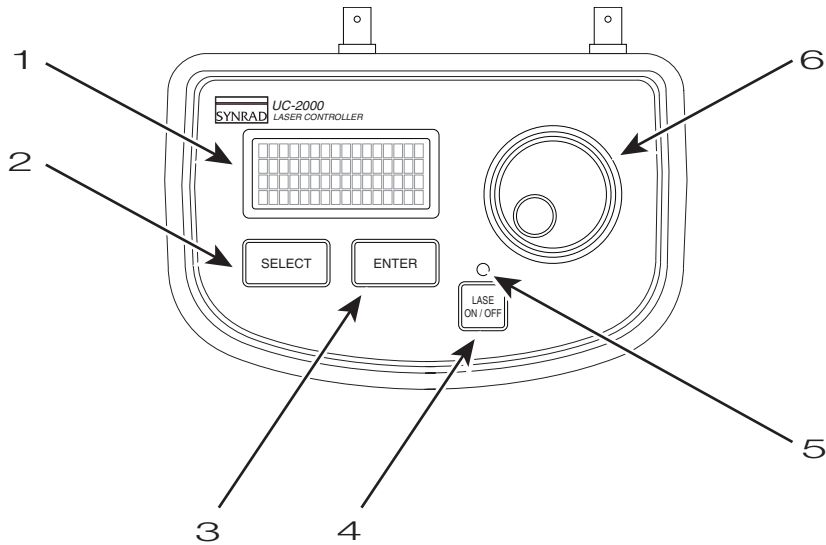

**Figure 2-1** Control panel

- 1 LCD Display – displays UC-2000 operating and setup parameters.
- 2 Select Pushbutton – scrolls through menu selections.
- 3 Enter Pushbutton – selects a menu item.
- 4 Lase On/Off Pushbutton – press to toggle the laser On or Off using the current operating parameters.
- 5 Lase Indicator – illuminates red to indicate that PWM Command pulses are being sent to the laser (if the Gate input is active).
- 6 PWM Adj Knob – rotate to change PWM duty cycle. When setting PWM duty cycle manually, rotate the PWM Adj Knob to change output in 0.5% increments or press down and turn to increase or decrease laser PWM duty cycle in 5% increments.

# operation

## Controls and indicators

### Rear panel

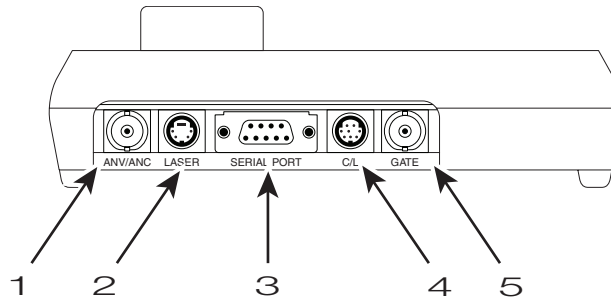

**Figure 2-2** Rear panel

- 1 ANV/ANC Connector – input BNC connector for applications using external analog voltage or current control signals.
- 2 Laser Connector – 4-pin mini-DIN connection for the *Power/Control* cable, which provides DC power to the Controller and sends tickle/PWM signals out to the laser.
- 3 Serial Port Connector – DB-9 connector allows a computer or programmable logic controller (PLC) to control the UC-2000 via an RS-232 serial port.
- 4 C/L Connector – 8-pin mini-DIN connector allows closed loop power control of lasers equipped with a SYNRAD closed loop kit.
- 5 Gate Connector – input BNC connector for applications using external gating signals to gate the laser beam on and off.

**Note:** All BNC connectors on the UC-2000 Controller are wired so that the signal is connected to the center pin and the signal return, or ground, is connected to the BNC shell.

# operation

## Controls and indicators

### LCD display

When power is first applied to the UC-2000 Controller, the firmware screen (shown in Figure 2-3) appears and displays the current firmware version.

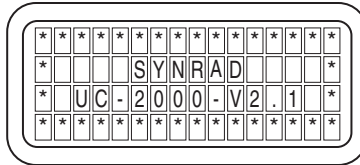

**Figure 2-3** Firmware screen

After a few moments, the display changes to the start-up screen shown in Figure 2-4.

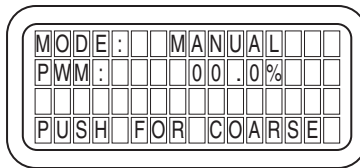

**Figure 2-4** Start-up screen

**Note:** On subsequent start-ups, the UC-2000 recalls the last saved operating parameters.

During normal operation, the UC-2000's LCD display contains four lines that display the following information:

Line 1 displays “**MODE:** ” and the currently selected operating mode.

Line 2 displays “**PWM:** xx.x%” or “**SET:** xx.x%”, the currently commanded PWM duty cycle in one-half percent increments.

In manual closed loop or ANV closed loop mode, Line 3 displays “**POWER:** xx.x%”, the actual regulated closed loop output power percentage.

Line 4 displays information about the currently displayed control mode.

# operation

## Initial start-up

To initially test your UC-2000 Universal Laser Controller, perform the following steps:

 **Warning**  
possible  
personal  
injury

Ensure that all personnel in the area are wearing protective eyewear. Read and follow all safety precautions described in your laser's *Operator's Manual* before beginning operation.

- 1 Place a beam block in front of the laser's output aperture to prevent the beam from traveling beyond the work area.
  - 2 Ensure that all personnel in the area are wearing protective eyewear, then apply power to both the laser and the UC-2000.
  - 3 Press the *Select* pushbutton and scroll through the menu until Line 4 in the LCD display reads "**FUNC: MANUAL**".
  - 4 Press the *Enter* pushbutton to choose the MANUAL mode of operation.
  - 5 If your laser is equipped with a keyswitch, turn it "On" (clockwise). The laser's green *PWR* indicator (Series 48 laser) or yellow *Ready* indicator (Evolution™ or Firestar® laser) illuminates and, after a five-second delay, the laser is ready to lase.
  - 6 Press the *Lase On/Off* pushbutton. The red *Lase* indicator on the UC-2000 and the laser's *LASE* indicator will both illuminate.
  - 7 Rotate the *PWM Adj Knob* to set laser power in 0.5% increments or press down and rotate to change power in 5% increments. Laser output should increase and decrease correspondingly. If the laser fails to fire, refer to the Troubleshooting chapter.
- Note:** Although the ratio of laser output to its power input is nonlinear, laser output is approximately proportional to PWM duty cycle. The curve of laser output versus PWM duty cycle also varies slightly when different PWM frequencies are used.
- 8 Press the *Lase On/Off* pushbutton to halt lasing. The red *Lase* indicator on the UC-2000 and the laser's *LASE* indicator will both turn off.

# operation

## Setup

Setup mode allows you to select operating parameters such as PWM frequency, gate logic, and maximum PWM percentage. To enter Setup mode when power is first applied, press and hold the *Enter* pushbutton while the firmware screen is displayed. Enter Setup mode at any time by pressing *Enter* and *Select* buttons simultaneously. After a few seconds the first setup screen (Figure 2-5) appears with the top line, “FREQUENCY: xxKHZ”, flashing.

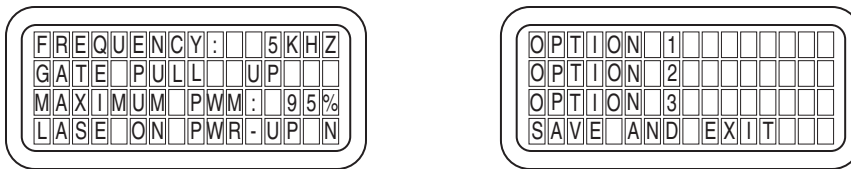

Figure 2-5 Setup screens

Press the *Select* pushbutton to scroll through setup parameters. When “SAVE AND EXIT” is flashing, press *Enter* to exit Setup mode and write current parameters to memory. Each parameter is described in further detail below.

## Setting PWM frequency

The UC-2000 sends Pulse Width Modulation (PWM) signals to the laser at user-selectable frequencies of 5, 10, or 20 kHz. The standard modulation frequency of 5 kHz works well in most laser applications and provides the greatest depth of modulation (Figure 3-2 in the Technical Reference chapter). For applications that cannot tolerate the on/off nature of optical beam response but still require adjustable power levels, use a PWM frequency of 10 or 20 kHz.

To change the PWM frequency, perform the following steps:

- 1 Enter Setup mode and press the *Select* pushbutton until “FREQUENCY: xxKHZ” is flashing.
- 2 Press the *Enter* pushbutton. The current PWM frequency flashes.
- 3 Press *Select* to scroll through PWM frequency choices: 5, 10, or 20.
- 4 When the desired frequency is flashing, press *Enter* to choose that frequency as the current PWM frequency.
- 5 Press *Select* to go to the next parameter or press *Select* until “SAVE AND EXIT” flashes then push *Enter* to exit Setup mode and write operating parameters to memory.

# operation

## Setup

### Setting gate logic

A gate signal is available in all operating modes to gate, or switch, the laser. Connecting an external pulse train to the *Gate* connector (laser output enabled when gate input is active) causes the UC-2000 to rapidly switch the laser on and off. The laser's "on" power level is set by the UC-2000's *PWM Adj Knob* or by external ANC, ANV, or REMOTE inputs. When laser "off" time exceeds 200  $\mu$ s, a tickle signal is generated to maintain plasma ionization.

A gate signal by itself does not fire the laser; instead the gate input is logically ANDed with the state of the *Lase On/Off* pushbutton. The pushbutton must be On (*Lase* indicator illuminated) **and** the appropriate active gate signal must be applied to the *Gate* connector in order to fire the laser.

The default gate logic is pull up or normally on. Pull up logic means that the laser will fire **without** a gate signal present when the *Lase On/Off* pushbutton is pressed On.

Users who intend to use a gating signal should set the UC-2000's gate input logic to pull down or normally off. When set to pull down mode, a high-level signal in the range of +2.8 V to +5.0 VDC must be present at the *Gate* input connector in order to fire the laser. Pull down (normally off) logic ensures that the laser is always off in the event the gate signal is open or disconnected, or a "tri-state" (electrically floating) condition exists.

**Note:** PWM output pulses are NOT synchronized with the *Gate* input signal.

Set input gate logic to pull up (normally on) only if a gate signal is not used in your laser application or during laser setup. When the gate function is set to pull up (normally on), the laser will fire when the *Lase On/Off* pushbutton is pressed unless the *Gate* input connector is held in a logic low state or is short-circuited through a set of dry relay contacts.

To change input gate logic, perform the following steps:

- 1 In Setup mode, press the *Select* pushbutton until "GATE PULL xxxx" flashes.
- 2 Press the *Enter* pushbutton. The current gate mode flashes.
- 3 Press *Select* to scroll through gate logic choices: Up or Down.
- 4 When the desired input logic is flashing, press *Enter* to choose that mode as the current gate input mode.
- 5 Press *Select* to go to the next parameter or press *Select* until "SAVE AND EXIT" flashes then push *Enter* to exit Setup mode and write operating parameters to memory.

# operation

## Setup

### Setting max PWM percentage

The UC-2000's maximum PWM percentage (maximum allowable duty cycle) is adjustable to either 95 or 99%. The default maximum PWM percentage, 95%, allows the laser's plasma to cool slightly, increasing laser efficiency. A 99% PWM duty cycle should be used only when absolutely necessary and then only in applications where a gating signal limits long-term average power such as in a marking application.

**Note:** SYNRAD lasers are designed for maximum performance using a 95% duty cycle. Increasing the maximum PWM percentage beyond 95% greatly increases the laser's heat load with little or no corresponding increase in laser output power. Continuous operation at 99% duty cycle may lead to thermal instability and optical degradation.

To change the maximum PWM percentage, perform the following steps:

- 1 Press the *Select* pushbutton until “**MAXIMUM PWM: xx%**” is flashing.
- 2 Press the *Enter* pushbutton. The current PWM percentage flashes.
- 3 Press *Select* to scroll through maximum PWM choices: 95 or 99.
- 4 When the desired percentage is flashing, press *Enter* to choose that percentage as the current maximum PWM percentage.
- 5 Press *Select* to go to the next parameter or press *Select* until “**SAVE AND EXIT**” flashes then push *Enter* to exit Setup mode and write operating parameters to memory.

### Setting lase on power-up

Normal operation of the UC-2000 Controller requires an operator to press the *Lase On/Off* pushbutton to enable lasing after Controller power-up. This safety feature prevents inadvertent laser operation in the event that power is cycled off and then on again such as during a power failure. In integrated applications where the UC-2000 is mounted inside a control cabinet and is not readily accessible to equipment operators, the UC-2000 Controller can be programmed to start lasing immediately upon power-up.

# operation

## Setup

 **Warning**  
possible  
personal  
injury

When **LASE ON PWR-UP** is enabled, the system integrator is responsible for providing additional safe-guards to prevent accidental or unintended operation of the laser when power is applied to the UC-2000 Universal Laser Controller.

To enable lasing on power-up, perform the following steps:

- 1 Press the *Select* pushbutton until “**LASE ON PWR-UP x**” is flashing.
- 2 Press the *Enter* pushbutton. The current lase on power-up setting flashes.
- 3 Press *Select* to scroll through power-up settings: N or Y.  
  
The UC-2000’s default setting is “N” (No), lasing on power-up is disabled. Choose “Y” (Yes) to enable laser output **immediately** after power is applied to the UC-2000.
- 4 When the “Y” setting is flashing, press *Enter* to choose that setting as the current lase on power-up command.
- 5 Press *Select* to go to the next parameter or press *Select* until “**SAVE AND EXIT**” flashes then push *Enter* to exit Setup mode and write operating parameters to memory.
- 6 Follow all procedures to ensure that the laser is safe to fire (or disconnect the *Power/Control* cable to prevent firing) and then press the *Lase On/Off* pushbutton.
- 7 When the red *Lase* indicator illuminates, wait six seconds until the UC-2000 beeps twice. This indicates that the new *Lase On Power-Up* setting is saved into memory.
- 8 Power down the UC-2000 Controller.

The next time the UC-2000 is powered up, the *Lase* indicator will illuminate and the laser will begin firing immediately at the commanded power setting (provided that the *Gate* input is active).

# operation

## Setup

### Setting option 1–3

This functions are reserved for future use and are not currently used.

## Save and exit

Press *Select* to loop back around to the first setup parameter or push *Enter* to exit Setup mode and write operating parameters to memory. On exit, the Controller beeps twice to indicate that operating parameters were successfully saved to non-volatile memory.

## Factory default settings

Table 2-1 lists factory default settings for the UC-2000 Controller.

**Table 2-1** Factory default settings

<b>Parameter</b>	<b>Default Setting</b>
Frequency.....	5 kHz
Gate.....	Pull Up
Maximum PWM Duty Cycle.....	95%
Lase on Power-Up .....	N (No)

# operation

## UC-2000 control

You can control the UC-2000 using either of two methods: *local control*, using panel knobs and buttons; or *REMOTE control*, using RS-232 serial port commands. Both methods allow you to control laser operation including output power adjustment and On/Off status.

### Local control

#### PWM Adj Knob

Use the *PWM Adj Knob* (Item 6 in Figure 2-1) to manually set the laser's output power by varying the duty cycle of the PWM Command signal. Rotate the knob clockwise or counter-clockwise to increase or decrease the PWM duty cycle in 0.5% increments. To make larger changes, press the *PWM Adj Knob* down while turning to make changes in 5% increments. See *Control signals* in the Technical Reference chapter for descriptions of control signals generated by the UC-2000 Controller.

#### Select/Enter pushbuttons

Press the *Select* pushbutton (Item 2 in Figure 2-1) to scroll through selections in the current menu. Press the *Enter* pushbutton (Item 3) to choose the currently displayed operating mode in the main menu or to choose the flashing option in the Setup menu. Press and hold *Enter* when power is first applied (while the firmware screen is displayed) to enter Setup mode. To enter Setup mode at any time, press and hold both *Select* and *Enter* buttons simultaneously.

#### Lase On/Off pushbutton

The *Lase On/Off* pushbutton acts like a toggle switch to enable/disable lasing. Press the *Lase On/Off* pushbutton once to begin lasing; press it again to halt lasing. The red *Lase* LED above the *Lase On/Off* pushbutton illuminates when PWM Commands are being sent to the laser.

**Note:** For safety reasons, lasing is automatically disabled and the *Lase* indicator is turned off if a new operating mode is selected while the laser is being commanded to lase.

When the red *Lase* LED is off (with power applied to the Controller), the UC-2000 operates in Standby mode – sending only tickle pulses to maintain plasma ionization in the laser. See *Control signals* in the Technical Reference chapter for a description of control signals generated by the UC-2000 Controller.

The UC-2000 can be set to begin lasing automatically on power-up. To choose this option, Lase on Power-Up, refer back to the *Setup* section earlier in this chapter.

# operation

## UC-2000 control

### Autosave feature

Six seconds after the last pushbutton or *PWM Adj Knob* operation (in local UC-2000 control), the Controller automatically saves the current mode settings and PWM power percentage into non-volatile memory. After saving operational settings, the Controller beeps twice to indicate success. If power is removed and later reapplied, the UC-2000 Controller will power-up with the last saved operating mode and power settings.

**Note:** All REMOTE (RS-232) commands received by the UC-2000 are immediately saved to non-volatile memory.

## REMOTE (RS-232) control

### **Warning**

possible  
personal  
injury

To prevent accidental exposure to laser radiation while operating using REMOTE control, it is the responsibility of the user to ensure that the computer is properly configured and that suitable software is available to control the UC-2000.

Choosing REMOTE control, Figure 2-6, allows a host computer or programmable logic controller (PLC) to control the laser's desired output and operation through an RS-232 serial link.

Immediately on entry to REMOTE operation, the UC-2000 saves current *local control* settings and then recalls the last saved *REMOTE control* settings. Once in REMOTE, the *PWM Adj Knob* and *Laser On/Off* pushbutton are disabled but the LCD display and *Select/Enter* pushbuttons continue to operate normally. When exiting REMOTE operation, the UC-2000 saves current *REMOTE control* settings and then recalls the last saved *local control* settings.

See *External control* in the Technical Reference chapter for a complete list and description of REMOTE (RS-232) commands.

# operation

## UC-2000 control

**Note:** In response to a status request, the UC-2000 can report status data to the RS-232 link while it is in any *local control* or *REMOTE control* mode.

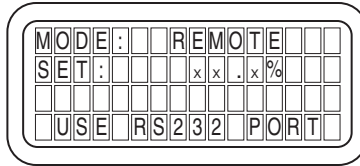

**Figure 2-6** REMOTE mode

# operation

## Laser control

Laser output power is controlled by choosing one of five UC-2000 operating modes: MANUAL, ANC, ANV, MAN. CLOSED, and ANV CLOSED. When none of these modes is active, the Controller operates in Standby mode. Each operating mode is described in detail below.

When operating the Controller using *local control*, choose one of the UC-2000's five operating modes by pressing the *Select* pushbutton. Line 1 in the LCD display shows the various modes as you scroll through them. When the desired operating mode is displayed, press the *Enter* Pushbutton. Pressing *Enter* causes the displayed mode to become the active mode of operation.

When operating the UC-2000 via *REMOTE (RS-232) control*, choose an operating mode by sending the appropriate command byte to the Controller's *Serial Port* connector. Line 1 in the LCD display changes to indicate the newly selected *REMOTE control* operating mode, which you control by sending *REMOTE (RS-232)* commands. If your *REMOTE control* application does not use ANC, ANC or closed loop inputs, then you will operate in "MANUAL" *REMOTE* mode and adjust laser power "manually" by sending the appropriate command and data bytes to the RS-232 serial port.

**Note:** For safety reasons, lasing is automatically disabled and the *Lase* indicator is turned off if a new operating mode is selected while the laser is being commanded to lase (*Lase* indicator is illuminated).

## Operating modes

### Standby

During standby operation (power applied to the UC-2000 Controller with the *Lase* indicator off), the UC-2000 sends 5 kHz "tickle" pulses to pre-ionize laser gas to just below the lasing threshold. Tickle allows the laser to respond almost instantaneously to Command signals as the beam is switched off and on during laser operations. See *Control signals* in the Technical Reference chapter for descriptions of tickle and PWM Command signals.



# operation

## Laser control

### ANV

In analog voltage (ANV) mode, Figure 2-9, control laser power using an external analog 0–10 V source. The PWM duty cycle is continuously variable and changes proportionally to the applied voltage—zero at 0 V increasing to maximum power at 10 VDC. Line 2 in the display shows “PWM: xx.x%”, where xx.x is the commanded PWM duty cycle percentage. See *External control* in the Technical Reference chapter for ANV signal connections and specifications.

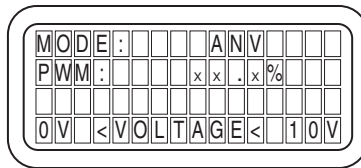

Figure 2-9 ANV mode

### MAN. CLOSED

Closed loop power control is available for SYNRAD lasers with a factory installed Closed Loop Stabilization Kit. See Appendix A for details.

When operating the UC-2000 using *local control*, Figure 2-10, adjust the laser’s desired output power (regulated setpoint) using the *PWM Adj Knob*. When operating the UC-2000 using *REMOTE control*, adjust the laser’s desired output power (regulated setpoint) “manually” by sending the appropriate command and data bytes to the RS-232 serial port.

In either case, closed loop sensor feedback regulates power stability within  $\pm 2\%$  of the setpoint. Closed loop settling time is typically two milliseconds (ms) after a change in setpoint. Line 2 in the display shows “SET: xx.x%”, where xx.x is the commanded power setpoint. Line 3 displays “POWER: xx.x%”, where xx.x is the actual regulated output power percentage. See *External control* in the Technical Reference chapter for closed loop signal connections and specifications.

**Note:** If “SET: xx.x%” and “POWER: xx.x%” values do not match, then closed loop control is set out of range (the “SET: xx.x%” value is outside the recommended upper or lower control limit range of 20–80% of rated output laser power).

# operation

## Laser control

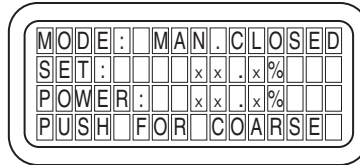

**Figure 2-10** MAN. CLOSED mode

### ANV CLOSED

Closed loop power control is available for SYNRAD lasers with a factory installed Closed Loop Stabilization Kit. See Appendix A for details.

In analog voltage closed loop control (ANV CLOSED) mode, Figure 2-11, the laser's desired output power (regulated setpoint) is controlled by an external analog voltage. Closed loop sensor feedback regulates power stability within  $\pm 2\%$  of the setpoint. Closed loop settling time is typically two milliseconds (ms) after a change in setpoint. Line 2 in the display shows "SET: xx.x%", where xx.x is the commanded power setpoint. Line 3 displays "POWER: xx.x%", where xx.x is the actual regulated output power percentage. See *External control* in the Technical Reference chapter for signal connections and specifications.

**Note:** If "SET: xx.x%" and "POWER: xx.x%" values do not match, then closed loop control is set out of range (the "SET: xx.x%" value is outside the recommended upper or lower control limit range of 20–80% of rated output laser power).

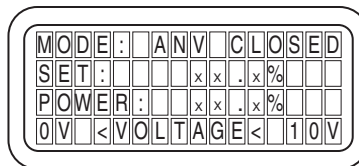

**Figure 2-11** ANV CLOSED mode

# operation

## Laser control

### Gate input

An externally-generated pulse train applied to the *Gate* BNC connector commands the UC-2000 to cycle the laser on and off. This gating signal, when used, is generated by the equipment controlling your laser application, typically a computer or programmable logic controller (PLC). Gate control is available in any of the five UC-2000 operating modes. See *External control* in the Technical Reference chapter for descriptions of gate signal connections and specifications.

**Note:** A gate signal by itself does not fire the laser; instead, the *Gate* input is logically ANDed with the state of the *Lase On/Off* pushbutton. The pushbutton must be On (*Lase* indicator illuminated) **and** the appropriate active gate signal must be applied to the *Gate* connector in order to fire the laser. See *Setting gate logic* earlier in this section for details on choosing the appropriate gate logic for your application.

# technical reference

Use information in this section as a technical reference for the UC-2000 Universal Laser Controller.

This sections contains the following information:

- Control signals – explains the control signals generated by the UC-2000.
- External control– explains how to connect externally-generated control signals to the UC-2000.
- Connector pinouts – describes Laser and Closed Loop (C/L) connector pinouts.
- General specifications – lists UC-2000 Controller specifications.
- UC-2000 package outlines – illustrates outline and mounting dimensions for both standard and panel mount UC-2000 Controllers.

# technical reference

## Control signals

### Tickle pulse

All SYNRAD lasers require a tickle pulse, a 5 kHz signal with a 1 microsecond ( $\mu\text{s}$ ) pulse width, which is normally delivered by the UC-2000 Controller. Tickle pulses pre-ionize the laser gas to just below the lasing threshold so that any further increase in pulse width adds enough energy to the plasma to cause laser emission. This causes the laser to respond predictably and almost instantaneously to PWM Command signals even when there is a considerable delay (laser off time) between applied On Command signals. The UC-2000 does not produce tickle pulses continuously, but generates them only when the PWM Command signal is low. Tickle pulses are sent one tickle period (200  $\mu\text{s}$ ) after the falling edge of a PWM Command signal. Figure 3-1 illustrates tickle pulse parameters.

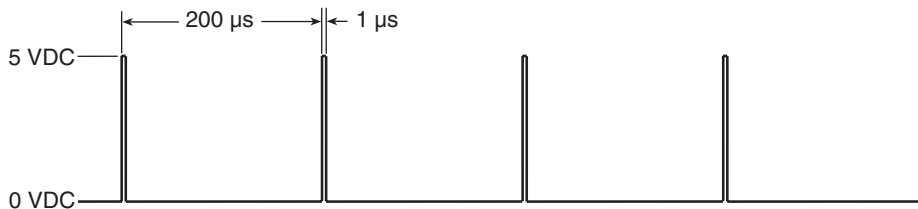

**Figure 3-1** Tickle pulse parameters

## Pulse Width Modulation (PWM)

The UC-2000 Universal Laser Controller controls laser power using pulse width modulation or PWM. A PWM Command signal controls laser output power by varying the duty cycle of the laser's RF amplifiers, which in turn controls the time-averaged RF power applied to the laser. At the standard 5 kHz PWM frequency, a pulse varying in width between 0  $\mu\text{s}$ , corresponding to zero power level and 190  $\mu\text{s}$ , corresponding to maximum power, controls laser output. Use the *PWM Adj Knob*, an RS-232 (REMOTE) command, or an external ANV/ANC signal to set a PWM duty cycle percentage.

The choice of PWM frequency—5, 10, or 20 kHz—depends on the user's specific application. For most applications, the UC-2000's standard frequency of 5 kHz has proven to work well. Optical output follows PWM input with a rise and fall time constant of approximately 75 to 150  $\mu\text{s}$ , depending on the laser model.

Laser output depends on its rise/fall time and the chosen PWM frequency/duty cycle. For any given laser, the percentage of optical output increases as duty cycle increases (at a constant

# technical reference

## Control signals

PWM frequency) or as PWM frequency decreases (at a constant duty cycle). Figure 3-2 shows representative optical output waveforms at two different duty cycles with the same PWM frequency.

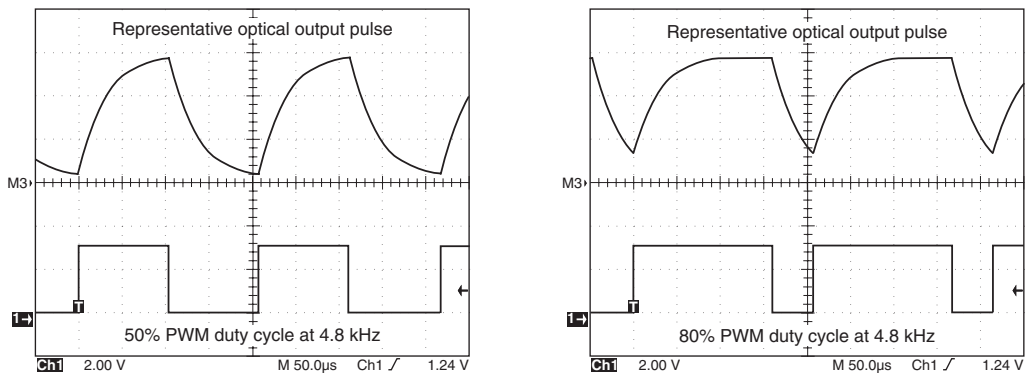

**Figure 3-2** Representative optical output waveforms

For high-speed motion applications that cannot tolerate any ripple in the optical beam response, but still need adjustable power levels, we recommend the use of a 20 kHz PWM frequency. At 20 kHz, the laser's optical beam response no longer follows the PWM Command signal and is very nearly a continuous wave (CW) value with just a small amount of ripple present.

## Command signal

The modulated Command signal from the UC-2000 has three basic parameters: signal amplitude, base frequency, and PWM duty cycle. By changing these parameters, you can command the beam to perform a variety of marking, cutting, welding, or drilling operations.

Signal amplitude is either logic low—corresponding to laser beam off, or logic high—corresponding to beam on. The laser off voltage, typically 0 V, can range from 0.0 V to +0.5 VDC while the laser on voltage, typically 5 V, can range from +3.5 V to +5.0 VDC.

Base frequency is the repetition rate of the PWM Command signal. The standard base frequency is 5 kHz, which has a pulse period of 200  $\mu$ s. The UC-2000 provides user-selectable PWM frequencies of 5 kHz, 10 kHz (100  $\mu$ s period), or 20 kHz (50  $\mu$ s period).

# technical reference

## Control signals

The third parameter, PWM duty cycle, is the percentage of the period that the Command signal is high. If the Command signal's amplitude (at 5 kHz) is high for 100  $\mu\text{s}$  and low for 100  $\mu\text{s}$ , it has a 50% duty cycle; if the amplitude is high for 190  $\mu\text{s}$  and low for 10  $\mu\text{s}$ , it has a 95% duty cycle. See Figure 3-3 for Command signal parameters. Table 3-1 provides PWM Command signal output specifications.

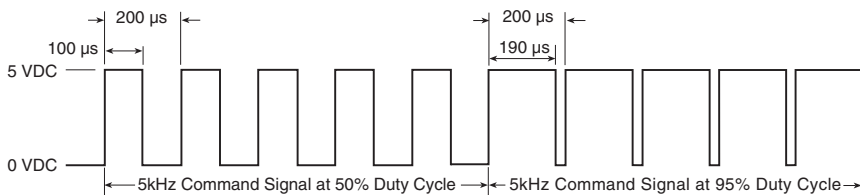

**Figure 3-3** Command signal parameters

When operating in MANUAL or MAN. CLOSED mode using *local control*, set the required PWM Command signal (duty cycle percentage) using the UC-2000's *PWM Adj Knob*.

When operating in MANUAL or MAN. CLOSED mode using *REMOTE control*, the PWM Command signal is controlled by a computer or PLC sending PWM or closed loop SET command and data bytes via an RS-232 serial interface.

When operating in ANC, ANV, or ANV CLOSED modes using *local control* or *REMOTE control*, an external analog signal controls laser output power.

**Table 3-1** Command signal output specifications

Parameter	Specifications
Output Voltage	Logic low: 0.0 V to +0.5 VDC (laser off) Logic high: +3.5 V to +5.0 VDC max (laser on)
Output Current, max.	100 mA

# technical reference

## External control

There are several methods for externally controlling PWM duty cycle including analog voltage or current control, closed loop control, and REMOTE (RS-232) control. In addition, the gate input can be used with any of these control methods as well as with manual PWM control. Using the gate input allows you to gate, or cycle, the laser on and off with an external pulse train at a specific power level. Each method of external control is described below.

**Note:** All BNC connectors on the UC-2000 are wired so that the signal is connected to the center pin and the signal return, or ground, is connected to the BNC shell.

### Gate input

An externally-generated gating signal or pulse train applied to the *Gate* BNC connector commands the UC-2000 to cycle the laser on and off. The gating signal, when used, is generated by the equipment controlling your laser application. Typically a function generator, computer, or programmable logic controller (PLC) would send signals through a digital I/O card to the UC-2000's *Gate* connector. Gate control is available in any operating mode.

Gating amplitude can be either of two states. A logic low state (0 V to +0.9 VDC) turns the laser off. A logic high state (+2.8 VDC to +5 VDC) turns the laser on. When the gate signal is active, PWM pulses are sent out asynchronously through the *Laser* connector. The PWM Command signal (PWM pulses) controls laser output power while the gate signal provides laser on/off timing control. Figure 3-4 illustrates the relationship between tickle, PWM, and *Gate* signals to UC-2000 output.

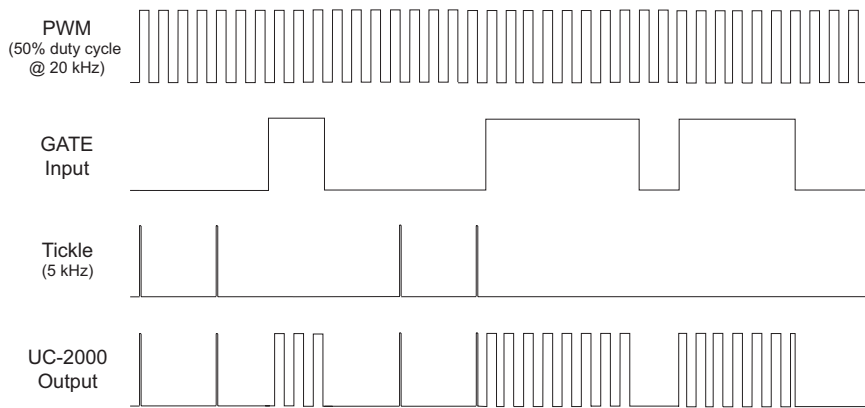

**Figure 3-4** UC-2000 input/output signal relationships

# technical reference

## External control

**Important Note:** PWM and gate pulses are asynchronous; the edges of PWM output pulses are NOT synchronized with the edges of gating pulses.

**Note:** A gate signal by itself does not fire the laser; instead the gate input is logically AND-ed with the state of the *Lase On/Off* pushbutton. The pushbutton must be On (*Lase* indicator illuminated) **and** the appropriate active gate signal must be applied to the *Gate* connector in order to fire the laser.

The UC-2000's gate input function has two settings: Gate Pull Up (normally on) and Gate Pull Down (normally off). When Gate Pull Up is chosen, UC-2000 circuitry connects an internal resistor to pull the *Gate* input up to an active level, which means that **the laser will fire without a gate signal present** when the *Lase On/Off* pushbutton is pressed. Set your gate configuration to Gate Pull Up (normally on) only if you do **not** use gate signal in your laser application.

If you plan to use an external gating signal, set the gate configuration to Gate Pull Down, which disconnects the internal pull-up resistor from the circuit. When set to Gate Pull Down, a voltage in the range of +2.8 V to +5.0 VDC must be present on the *Gate* input for the laser to fire when the UC-2000's *Lase On/Off* pushbutton is pressed. Gate Pull Down (normally off) logic ensures that the laser is always off in the event the gate signal is open or disconnected, or if a "tri-state" (electrically floating) condition exists. See *Setup* in the Operation chapter for details on configuring gate logic. Table 3-2 provides *Gate* input signal specifications.

**Table 3-2** Gate input specifications

Parameter	Specifications
Input Voltage	Logic low: 0.0 V to +0.9 VDC (laser off) Logic high: +2.8 V to +5.0 VDC max (laser on)
Input Impedance	50 kOhms
Gate On Time, min.	3.5 $\mu$ s
In closed loop mode	> 10 ms

# technical reference

## External control

### Analog control

Several methods for external analog control of PWM power percentage are available through the UC-2000. ANC and ANV control methods are fully described below; computer or PLC control of PWM is discussed later in this section.

### Analog current control

Analog current (ANC) control of laser power is accomplished by using a 4–20 mA current loop. The majority of ANC applications use specialized control software running on a PLC or computer with a digital-to-analog converter (D/A or DAC) card, although the ANV/ANC input can be driven from a purely analog source such as a remote potentiometer. Table 3-3 shows analog current signal specifications.

Follow the steps below to set your UC-2000 Controller for ANC control:

- 1 Press the *Select* pushbutton until Line 4 in the LCD display shows “FUNC: ANC”.
- 2 Press *Enter* to choose ANC as the currently active operating mode.
- 3 Connect a coaxial cable from your analog current source to the ANV/ANC connector on the rear of the UC-2000.
- 4 If required, connect a coaxial cable from your gating source to the *Gate* connector.
- 5 From your computer or PLC, send an analog current signal (between 4 mA and 20 mA) that corresponds to the desired output power percentage.
- 6 Press the *Lase On/Off* pushbutton to begin lasing.

**Table 3-3** Analog current specifications

Parameter	Specification
Current Range	4–20 mA, $\pm 5\%$
Power Output, typ.	zero @ 4 mA, maximum @ 20 mA
Safe Input Current, max.	100 mA
Input Impedance	220 Ohms

# technical reference

## External control

### Analog voltage control

Analog voltage (ANV) control of laser output power is accomplished by using an analog 0–10 VDC signal. The majority of ANV applications use specialized control software running on a computer or PLC with a digital-to-analog converter (D/A or DAC) card, although the ANV/ANC input can be driven from purely analog sources such as a remote potentiometer or adjustable power supply. Analog voltage control is also available in the ANV CLOSED mode described in the *Closed loop control* section. See Table 3-4 for analog voltage signal specifications.

Follow the steps below to set your UC-2000 Controller for ANV control:

- 1 Press the *Select* pushbutton until Line 4 in the LCD display shows “FUNC: ANV”.
- 2 Press *Enter* to choose ANV as the currently active operating mode.
- 3 Connect a coaxial cable from your analog voltage source to the ANV/ANC connector on the rear of the UC-2000.
- 4 If required, connect a coaxial cable from your gating source to the *Gate* connector.
- 5 From your computer or PLC, send an analog voltage signal (between 0 and 10 VDC) that corresponds to the desired output power percentage.
- 6 Press the *Lase On/Off* pushbutton to begin lasing.

**Table 3-4** Analog voltage specifications

Parameter	Specifications
Voltage Range	0–10 VDC, $\pm 5\%$
Power Output, typ.	zero @ 0 V (<100 mV), maximum @ 10 VDC
Safe Input Voltage, max.	+15 VDC
Input Impedance	10 kOhms

# technical reference

## External control

### Closed loop control

Two closed loop power regulation modes are available: manual closed loop control (MAN. CLOSED) or analog voltage closed loop control (ANV CLOSED).

#### Manual closed loop

In manual closed loop (MAN. CLOSED) mode, the desired regulated setpoint is set using the *PWM Adj Knob (local control)* or by sending command and data bytes to the UC-2000 Controller's RS-232 serial port (*REMOTE control*). Closed loop power regulation is maintained by the laser's closed loop kit.

Follow the steps below to set your UC-2000 Controller for MAN. CLOSED control:

- 1 Press the UC-2000's *Select* pushbutton until Line 4 in the LCD display shows "**FUNC: MAN. CLOSED**".
- 2 Press *Enter* to choose MAN. CLOSED as the currently active operating mode.
- 3 Connect the cable from your laser's closed loop kit to the C/L 8-pin mini-DIN connector on the rear of the UC-2000.
- 4 If required, connect a coaxial cable from your gating source to the *Gate* connector.
- 5 Rotate the *PWM Adj Knob* (or send RS-232 command and data bytes) to set the desired regulated power percentage within the range of 20–80% of full rated power.

**Note:** The window on either side of the regulated range allows the closed loop controller to maintain power stability over the full dynamic range. If the "**SET: xx.x%**" and "**POWER: xx.x%**" values in the LCD display do not match, this means that closed loop control is out of range. Adjust the "**SET: xx.x%**" value until it is within the upper or lower control limits.

- 6 Press the *Lase On/Off* pushbutton to begin lasing.

#### Analog closed loop

In analog voltage closed loop (ANV CLOSED) mode, an analog voltage between 0–10 VDC on the ANV/ANC connector sets the desired setpoint while closed loop power regulation is maintained by the laser's closed loop kit. The majority of ANV CLOSED applications use specialized control software running on a computer or PLC with a digital-to-analog converter (D/A or DAC) card, although the ANV/ANC input can be driven from purely analog

# technical reference

## External control

sources such as a remote potentiometer or an adjustable power supply. Table 3-5 shows analog voltage closed loop signal specifications.

Follow the steps below to set your UC-2000 Controller for ANV CLOSED control:

- 1 Press the *Select* button until Line 4 in the display shows “**FUNC: ANV CLOSED**”.
- 2 Press *Enter* to choose ANV CLOSED as the currently active operating mode.
- 3 Connect the cable from your laser’s closed loop kit to the C/L 8-pin mini-DIN connector on the rear of the UC-2000.
- 4 Connect a coaxial cable from your analog voltage source to the ANV/ANC connector on the rear of the UC-2000.
- 5 If required, connect a coaxial cable from your gating source to the *Gate* connector.
- 6 Apply an analog voltage between approximately 2–8 VDC that corresponds to the desired regulated power percentage within the range of 20–80% of full rated power.

**Note:** The window on either side of the regulated range allows the closed loop controller to maintain power stability over the full dynamic range. If the “**SET: xx.x%**” and “**POWER: xx.x%**” values in the LCD display do not match, this means that closed loop control is out of range. Adjust the “**SET: xx.x%**” value until it is within the upper or lower control limits.

- 7 Press the *Lase On/Off* pushbutton to begin lasing.

**Table 3-5** Analog voltage closed loop specifications

Parameter	Specifications
Voltage Range	0–10 VDC, $\pm 5\%$
Power Output, typ.	zero @ 0 V (<100 mV), maximum @ 10 VDC
Safe Input Voltage, max.	+15 VDC
Input Impedance	10 kOhms

# technical reference

## External control

### REMOTE (RS-232) control

REMOTE (RS-232) control of the UC-2000 is accomplished by sending control data to the UC-2000's RS-232 serial port from a host computer or PLC. Immediately on entry to REMOTE operation, the UC-2000 saves current *local control* settings and then recalls the last saved REMOTE control settings. Once in REMOTE, the *PWM Adj Knob* and *Laser On/Off* pushbutton are disabled, but the LCD display and *Select/Enter* pushbuttons continue to operate normally. When exiting REMOTE operation, the UC-2000 saves current REMOTE control settings and then recalls the last saved *local control* settings.

Follow the steps below to set your UC-2000 Controller for REMOTE control:

- 1 Connect a standard serial cable between the host's serial port and the *Serial Port* connector on the rear of the UC-2000.
- 2 Press the *Select* pushbutton until Line 4 in the display shows "MODE: REMOTE".
- 3 Press *Enter* to choose REMOTE as the currently active control method.

**Note:** Exit REMOTE operation by pressing the *Select* pushbutton until the desired local control mode is displayed. Press *Enter* to choose the new control method.

- 4 Send REMOTE commands as described below to remotely operate the UC-2000.

### Serial Port connector

Connect to the UC-2000's *Serial Port* connector using a standard serial cable. Figure 3-5 illustrates the physical layout of the *Serial Port* connector on the rear of the UC-2000 Laser Controller.

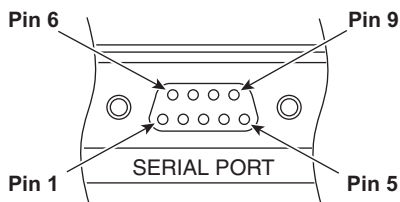

**Figure 3-5** Physical layout of RS-232 *Serial Port* connector

# technical reference

## External control

Table 3-6 provides pin assignments for the UC-2000's RS-232 *Serial Port* connector.

**Table 3-6** UC-2000 RS-232 pin assignments

Pin #	Function
2	Transmit Data (TD)
3	Receive Data (RD)
5	Signal Ground (SG)

If you choose to build a custom length serial cable to connect between the host's serial port and the UC-2000 Controller's *Serial Port* connector, refer to Figure 3-6; it illustrates a typical three-wire serial cable.

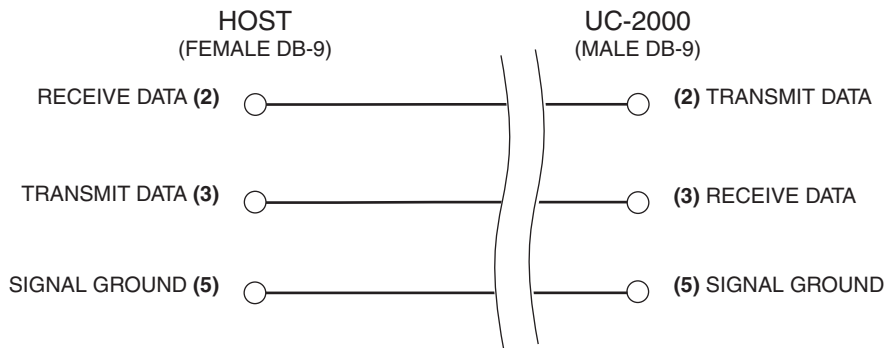

**Figure 3-6** RS-232 cable wiring diagram

# technical reference

## External control

### Host serial port configuration

In order to communicate through the UC-2000's RS-232 serial port, you must configure the host computer's (or PLC's) serial port protocol. Table 3-7 provides RS-232 configuration specifications for the UC-2000 Laser Controller.

**Table 3-7** Host serial port configuration

<b>Parameter</b>	<b>Specifications</b>
Baud Rate	9600
Data Bits	8 bits
Parity	None
Stop Bits	1 bit
Flow Control	None

### REMOTE commands

The following command sets are available for controlling the UC-2000 from a host computer or PLC. Most command sets consist of a single hexadecimal byte (designated by the suffix h), except for the PWM/SET percentage command which consists of two bytes, a command byte and a data byte. Upon completion of a valid status or command request, the Controller returns a single byte, AAh, as an acknowledgment of success. Note that all REMOTE commands sent to the Controller from a host computer or PLC are immediately saved to non-volatile memory. Each command set listed below is described on the following pages.

UC-2000 REMOTE command sets include:

- Mode commands

- Lase commands

- Setup commands

- PWM (or closed loop SET) percentage command

- Status command

# technical reference

## External control

Tables 3-8 – 3-12 list REMOTE software commands available to control the UC-2000.

**Note:** The letters in brackets following the hex command bytes are keyboard shortcuts useful for entering commands in a serial communications program such as HyperTerminal instead of typing hexadecimal numbers.

 **Warning**  
possible  
personal  
injury

To prevent accidental exposure to laser radiation while operating in *REMOTE control*, it is the responsibility of the user to ensure that the computer is properly configured and that suitable software is available to control the UC-2000.

**Table 3-8** REMOTE Mode commands

Function	Command	Response
Set MANUAL mode	70h [p]	AAh
Set ANC mode	71h [q]	AAh
Set ANV mode	72h [r]	AAh
Set MAN. CLOSED mode	73h [s]	AAh
Set ANV CLOSED mode	74h [t]	AAh

**Table 3-9** REMOTE Lase commands

Function	Command	Response
Set laser enabled	75h [u]	AAh
Set laser standby	76h [v]	AAh

# technical reference

## External control

**Table 3-10** REMOTE Setup commands

Function	Command	Response
Set PWM freq=5K	77h [w]	AAh
Set PWM freq=10K	78h [x]	AAh
Set PWM freq=20K	79h [y]	AAh
Set Gate pull up	7Ah [z]	AAh
Set Gate pull down	7Bh [{]	AAh
Set max PWM=95%	7Ch [I]	AAh
Set max PWM=99%	7Dh [J]	AAh
Enable lase on power-up	30h [0]	AAh
Disable lase on power-up	31h [1]	AAh

**Table 3-11** REMOTE PWM (or SET) percentage command

Function	Command	Response
Set PWM (or C/L SET) percentage	7Fh [Alt 0127] + hex data byte	AAh

Set PWM (or closed loop SET) percentage, in minimum 0.5% steps, by sending two hexadecimal bytes, a command byte (7Fh) and a data byte. To send a PWM or SET percentage command to the UC-2000 Controller, first multiply the desired PWM percentage by two, then convert the result to hexadecimal. For example, to command a 70% PWM percentage, multiply  $70 \times 2$ . Convert the result (140) to hexadecimal format and then send this data byte result (8Ch) after sending the 7Fh command byte.

If the UC-2000 does not receive a data byte within six seconds of receiving a 7Fh command byte, the PWM or SET percentage input command is halted.

**Note:** Commanding a PWM or SET percentage of 63 (7Eh) is interpreted as a “Get Status” request. Send a data byte value of 62.5% (7Dh) or 63.5% (7Fh) instead.

# technical reference

## External control

**Table 3-12** REMOTE Status command

Function	Command	Response
Get status	7Eh [-]	AAh; Status byte1; Status byte2; PWM byte; Power byte (A 1 ms pause occurs between each byte sent in response)

Read Status byte 1 as follows:

**Bit 0-2** Current operating mode (Bit 0 = LSB; Bit 2 = MSB) where 000 = MANUAL (factory default); 001 = ANC; 010 = ANV; 011 = MAN CLOSED; 100 = ANV CLOSED; 101 = REMOTE

**Bit 3** Control status where 0 = Off (local control); 1 = On (REMOTE control)

**Bit 4** Laser On/Off status where 0 = Off; 1 = On

**Bit 5** Gate pull up/pull down status where 0 = pull down; 1 = pull up (factory default)

**Bit 6-7** PWM frequency (Bit 6 = LSB; Bit 7 = MSB) where 00 = 5 kHz (factory default); 01 = 10 kHz; 10 = 20 kHz

Read Status byte 2 as follows:

**Bit 0** Lase on power-up status where 0 = No (factory default); 1 = Yes

**Bit 1** Maximum PWM percentage status where 0 = 99%; 1 = 95% (factory default)

**Bit 2-3** Reserved

**Bit 4-7** Software version number (Bit 4 = LSB; Bit 7 = MSB)

Read PWM and Power bytes as follows:

The reply, ranging from 00h to C6h, indicates a PWM percentage between 0–99% expressed in hexadecimal format. Convert the hex byte to decimal and then divide by two (a PWM percentage return of 7Bh equals  $123/2$  which equals 61.5%). The returned PWM byte is equivalent to the commanded PWM duty cycle percentage shown in the LCD display.

In closed loop mode, the PWM byte returns the commanded SET value, and the Power byte returns the actual regulated POWER shown in the display. Power bytes are valid only when operating the UC-2000 in MAN. CLOSED or ANV CLOSED closed loop modes.

**Note:** The UC-2000 can report its status to the RS-232 link while in any operating mode.

# technical reference

## Connector pinouts

### Laser connector

The *Laser* connector on the rear of the UC-2000 is a four-pin mini-DIN type. Table 3-13 shows *Laser* connector pinouts. The PWM cable is a type RG174/U coaxial cable.

**Table 3-13** Laser connector pinouts

Pin number	Function	Description
1	GND	Ground connection for Pin 2 or Pin 3
2	+Vcc	15–50 VDC input, 35 mA max.
3	PWM Out	PWM Command signal to laser
4	GND	Ground connection for Pin 2 or Pin 3

### Closed loop (C/L) connector

The *C/L* (Closed Loop) connector on the rear of the UC-2000 is an eight-pin mini-DIN type. Table 3-14 shows *C/L* connector pinouts.

**Table 3-14** C/L connector pinouts

Pin number	Function	Description
1	C/L In	0–10 VDC analog input, tied to Pin 4
2	C/L Out	12 VDC C/L supply, 3 mA, tied to Pin 7
3	GND	Ground connection
4	C/L In	0–10 VDC analog input, tied to Pin 1
5	GND	Ground connection
6	GND	Ground connection
7	C/L Out	12 VDC C/L supply, 3 mA, tied to Pin 2
8	GND	Ground connection

# technical reference

## General specifications

**Table 3-15** UC-2000 general specifications

### Parameter

#### UC-2000 Specifications

Power Input	15–50 VDC, 35 mA max.
PWM Output	100 mA, logic low 0.0 V to +0.5 VDC (laser off), logic high +3.5 V to +5.0 VDC max. (laser on)
Gate Input	Logic low 0.0 V to +0.9 VDC (laser off), logic high +2.8 V to +5.0 VDC max. (laser on)
Gate On Time, min.	3.5 $\mu$ s
In closed loop mode	>10 ms
Gate Input Impedance	50 kOhms
Clock Frequency	$\pm$ 10% accuracy

#### Environmental Specifications

Operating Temperature	0°C–40°C
Humidity	0–80%, non-condensing

#### Physical Specifications

Length	7.00 in.	(17.79 cm)
Width	4.23 in.	(10.74 cm)
Height	2.10 in.	(5.33 cm)
Weight	1.14 lbs	(0.52 kg)

#### UC-2000 Operating Modes

Standby	Input: none	Output: 1 $\mu$ s, 5 kHz Tickle signal
Manual	Input: <i>PWM Adj Knob</i>	Output: 0–99% max PWM signal (5, 10, or 20 kHz)
ANC	Input: 4–20 mA current, $\pm$ 5%, 100 mA max, Input impedance – 220 Ohms	Output: 0% @ 4 mA to 99% max PWM signal @ 20 mA (5, 10, or 20 kHz)
ANV	Input: 0–10 VDC, $\pm$ 5%, +15 VDC max, Input impedance – 10 kOhms	Output: 0% @ 0 V (<100 mV) to 99% max PWM signal @ 10 VDC (5, 10, or 20 kHz)
Man. Closed	Input: <i>PWM Adj Knob</i>	Output: 0–99% max PWM signal (5, 10, or 20 kHz)
ANV Closed	Input: 0–10 VDC, $\pm$ 5%, +15 VDC max, Input impedance – 10 kOhms	Output: 0% @ 0 V (<100 mV) to 99% max PWM signal @10 VDC (5, 10, or 20 kHz)
Remote	Input: software commands via RS-232 serial port	Output: Manual, ANC, ANV, Man. Closed Loop or ANV Closed Loop mode signal

\* Specifications subject to change without notice.

# technical reference

## UC-2000 package outlines

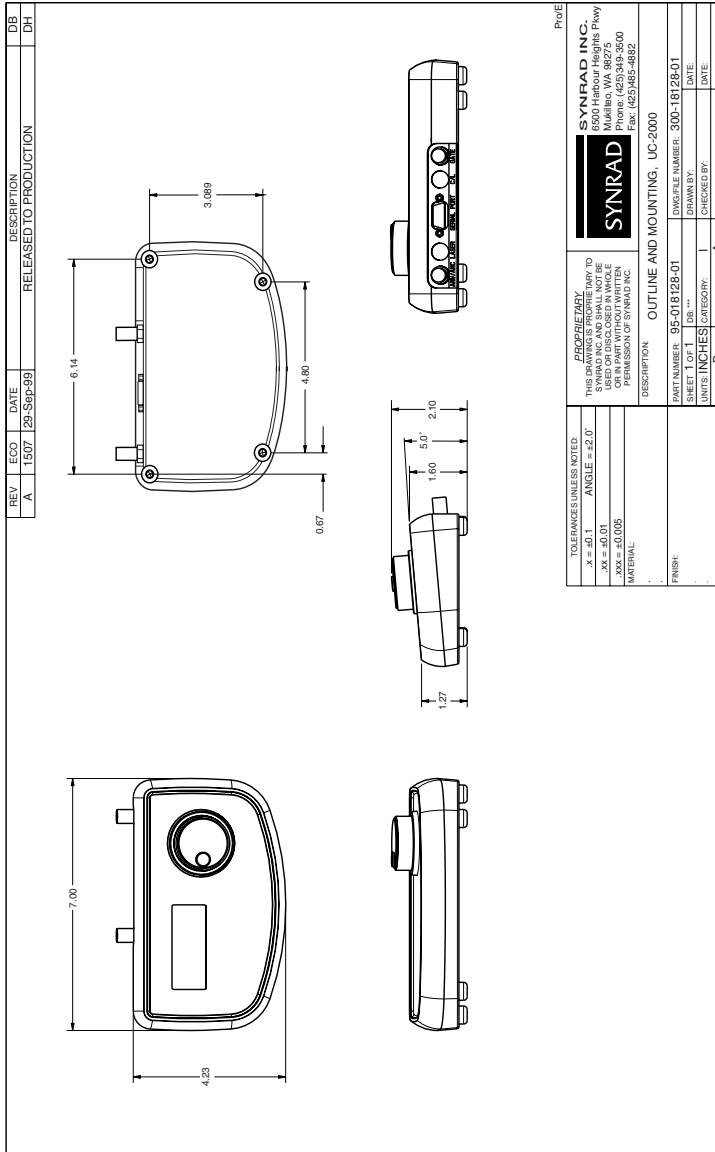

**Figure 3-7** UC-2000 package outline dimensions

# technical reference

## UC-2000 package outlines

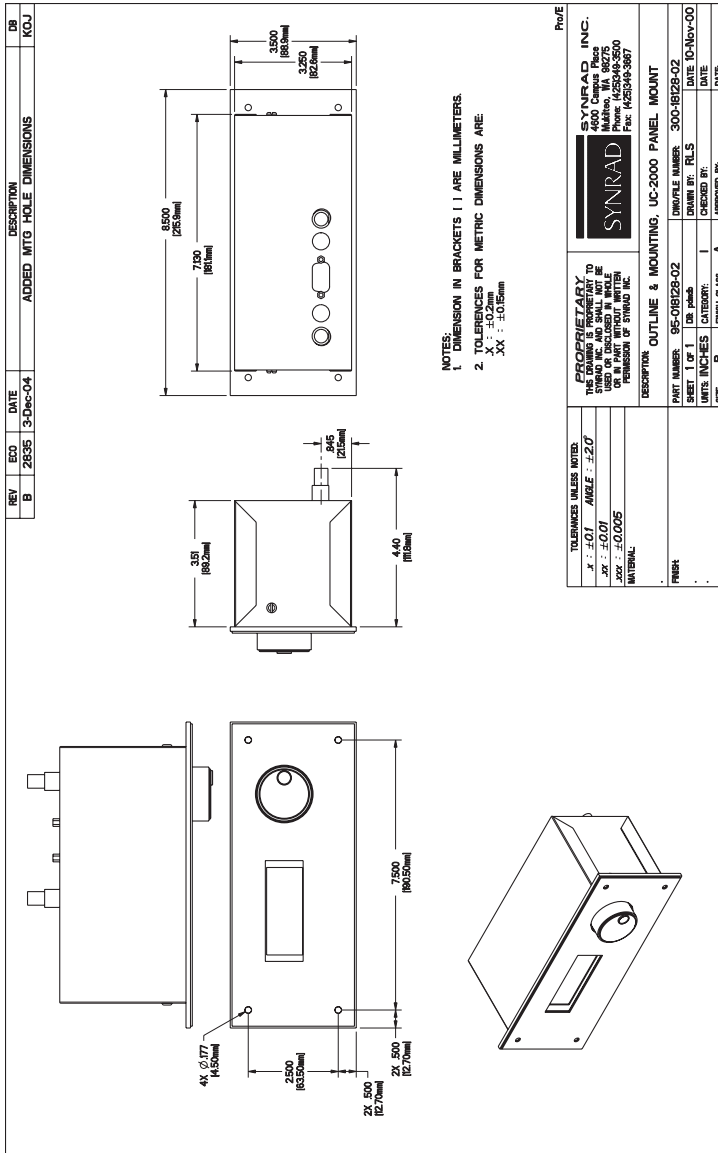

Figure 3-8 UC-2000 panel mount package outline dimensions

# troubleshooting

Use information in this section to troubleshoot of your UC-2000 Universal Laser Controller.

This section contains the following information:

- Troubleshooting – describes how to troubleshoot common problems.

# troubleshooting

## Troubleshooting

If your UC-2000 Controller fails to operate properly, first check the following items:

- Is DC power available?
- Is it within the specified voltage range? See *General Specifications* in the Technical Reference chapter.
- Is the Controller set for the proper control method – local or REMOTE?
- If operating using *REMOTE control*, are host serial port parameters set correctly? See Table 3-7 in the “Technical Reference” section.
- Is the Controller in the proper operating mode – MANUAL, ANC, ANV, MAN, CLOSED, or ANV CLOSED?
- Are Setup parameters (PWM frequency, gate logic, max PWM percentage, and lase on power-up) correct? See *Setup* in the Operation chapter.
- Are external connections to the rear panel properly made?
- Are external signals within the specified limits? See *External Control* in the Technical Reference chapter.

### Symptom:

- DC power is available and the *Lase* indicator is illuminated, but PWM pulses are not being sent to the laser.

### Possible Causes:

- Input gate logic is improperly set.

If you are **not** using a gating signal, check that the gate function is set to pull up (normally on). The laser should fire when the *Lase* indicator is lit unless the *Gate* input connector is held in a logic low state.

If you are using a gating signal, then the gate function should be set to pull down (normally off). The laser should fire when the *Lase* indicator is lit **and** the *Gate* input connector is held in a logic high state.

# troubleshooting

## Troubleshooting

- The input gate signal is not within specification.

Check the polarity and voltage level of the gating signal. The positive signal connects to the center pin of the BNC connector and the signal return, or ground, connects to the BNC shell. The high-level laser ON signal, typically +5.0 VDC, can range between +2.8 V and +5.0 VDC while the low-level laser OFF signal, typically 0.0 VDC, can range between 0.0 V and +0.9 VDC.

### Symptom:

- The Controller beeps three times immediately after power up.

### Possible Causes:

- Static discharge during storage or transportation has caused one or more of the saved settings in EEPROM memory to change while the UC-2000 was powered down.

Reprogram the UC-2000 Controller to the settings last used in your application. It should function normally after settings are reset to their previous values.

### Symptom:

- When operating using *REMOTE control*, sending a PWM (or SET) command of 63% results in a Status response from the UC-2000.

### Possible Causes:

- A 7Fh command byte followed by a 7Eh data byte is not recognized as a command to set the PWM or closed loop SET percentage to 63%; instead the 7Eh data byte is interpreted as a “Get Status” command.

Send a 7Fh PWM (or SET) command byte followed by a 7Dh (62.5%) or 7Fh (63.5%) data byte.

# troubleshooting

## Troubleshooting

### Symptom:

- The UC-2000 Controller is configured for *Lase On Power-Up* (the Setup screen shows “LASE ON PWR-UP Y”), but the laser does not fire when the UC-2000 Controller and laser are powered up.

### Possible Causes:

- After setting *Lase On Power-Up* to “Y” (Yes), an active lasing state must be saved.

Make sure that the laser is safe to fire (or disconnect the control cable to prevent lasing) and then press the *Lase On/Off* pushbutton. When the *Lase* indicator illuminates red, wait six seconds until the UC-2000 Controller beeps twice. This indicates that the *Lase On Power-Up* setting is saved into memory. See *Setup* in the “Operation” section for further details.

- Check that the gate configuration is correct and that the correct gating signal is applied.

See *Setup* in the Operation chapter and *External control* in the Technical Reference chapter for details on gate setup and operation.

- Check that the laser is powered up and ready to lase.

Verify that the laser’s green *PWR* indicator (Series 48 laser) or yellow *Ready* indicator (Evolution™ or Firestar® laser) is illuminated; five-seconds later lasing is enabled.

If the UC-2000 Universal Laser Controller still fails to function properly, contact SYNRAD, Inc. or a SYNRAD Authorized Distributor for assistance.

# appendix a

Use information in this section to connect and operate your Closed Loop (C/L) Stabilization Kit.

This section contains the following information:

- Introduction – explains how the closed loop kit functions.
- Safety precautions – lists laser safety precautions.
- Connecting – describes how to connect the closed loop kit to your UC-2000 Controller.
- Operation – describes closed loop operation.
- Closed loop specifications – provides technical specifications for the Closed Loop Stabilization Kit.

# appendix a

## Closed Loop Stabilization Kit

### Introduction

The Closed Loop (C/L) Stabilization Kit is available for 10 W, 20 W, and 25 W SYNRAD lasers and must be installed and calibrated at the factory. The closed loop kit provides an effective, reliable method of stabilizing laser power output by optically sampling the beam and providing feedback to adjust the PWM duty cycle percentage of the UC-2000's output PWM Command signal.

After installation, the beam passes through an optical sampler (which replaces the standard front plate) before it exits the closed loop housing. Optical beam transmission is 92% since the sampler diverts approximately 8% of the output beam to a diffuser and thermopile detector. The detector signal is amplified and sent to the UC-2000 where the Controller generates a variable duty cycle signal to maintain constant average laser output power.

**Note:** Once installed and aligned on the laser, the Closed Loop Stabilization Kit becomes part of the loop response/gain parameter and must NOT be moved or adjusted. Any user modifications or adjustments will void the product warranty.

### Safety precautions



#### Warning

possible  
personal  
injury

Please read these instructions carefully before using your laser with a Closed Loop Stabilization Kit. To prevent injury to personnel or damage to your laser or CL Kit, follow all safety precautions and setup instructions as described here and in your laser's *Operator's Manual*. Safe operating practices should be exercised at all times when actively lasing to prevent exposure to direct or scattered laser radiation. Improper handling or operation may result in exposure to hazardous invisible laser radiation, damage to, or malfunction of the laser or Closed Loop Stabilization Kit. Severe burns will result from exposure to the laser beam. Always wear safety glasses with side shields to reduce the risk of damage to the eyes when operating the laser.

# appendix a

## Closed Loop Stabilization Kit

### Connecting

Refer to Figure A-1 for an illustration of a typical closed loop system and then perform the following steps:

- 1 Disconnect power from your laser and the UC-2000 Controller.
- 2 Connect one end of the *CL Interconnect* cable to the laser-mounted closed loop assembly and the other end to the UC-2000's 8-pin mini-DIN C/L connector.
- 3 If required, connect a gating signal to the UC-2000's *Gate* BNC connector.
- 4 If required, connect an ANV signal from your analog voltage source to the UC-2000's *ANV/ANC* BNC connector.
- 5 Set the UC-2000 to MAN. CLOSED or ANV CLOSED mode.
- 6 Apply power to both the laser and UC-2000 and then verify proper system operation.

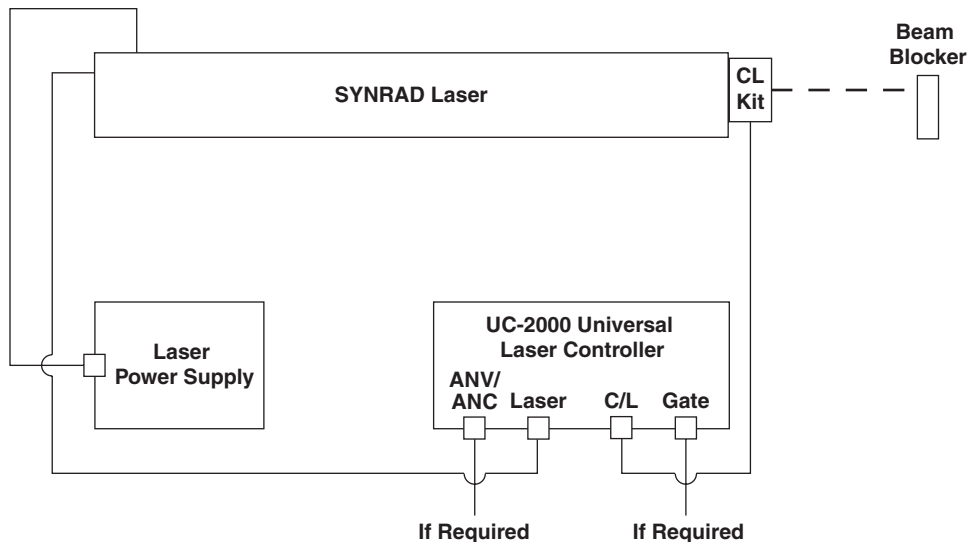

**Figure A-1** Typical closed loop setup

# appendix a

## Closed Loop Stabilization Kit Operation

Set the UC-2000 to MAN. CLOSED or ANV CLOSED mode. Adjust the regulated setpoint to provide a laser power output between approximately 20–80% of full power. This 20% window on either side of the range allows the Controller to maintain full dynamic power regulation. Within the dynamic response time of the system, the UC-2000 Controller can be gated from an external, low-frequency signal source through the *Gate* connector.

**Note:** When operating in either closed loop mode, power output is no longer a curve of laser output versus PWM duty cycle but instead, laser power output becomes a linear function of the desired setpoint percentage.

For the closed loop kit, servo settling time to 90% of final value occurs within approximately 2 milliseconds. Output power regulation is typically  $\pm 2\%$ , even when the beam “line hops” between 10.57 and 10.63 micrometers ( $\mu\text{m}$ ).

## Closed loop specifications

**Table A-1** Closed loop general specifications

Parameter	Specification
Optical Transmission	92%, $\pm 1\%$
Power Input, optical	150 W maximum
Power Input, electrical	12 VDC @ 3 mA (provided by UC-2000)
Power Stability, five minutes after cold start	$\pm 2\%$
Control Range	20–80% of rated output power
Control Frequency <sup>1</sup>	5 kHz
Servo Settling Time, typical	2 ms

\* Specifications subject to change without notice.

1 The Closed Loop Stabilization Kit is calibrated for operation at a PWM Command frequency of 5 kHz.

# index

## A

- Agency compliance
  - see Compliance
- Analog control 2-15, 2-16, 2-17, 3-7–3-8
- Analog current control
  - specifications 3-7
- Analog voltage
  - specifications 3-8
- ANC mode 2-15, 3-4, 3-7
- ANV/ANC connector 2-3, 3-7, 3-8, 3-9, A-3
- ANV closed loop specifications 3-10
- ANV CLOSED mode 2-17, 3-4, 3-9–3-10, A-3, A-4
- ANV mode 2-16, 3-4, 3-8
- Autosave 2-12

## B

- Beam block 2-5
- BNC Control cable 1-2, 1-5, 1-6
- BNC Tee 1-2, 1-5, 1-6

## C

- C/L connector 2-3, 3-9, 3-10, 3-17, A-3
- Caution
  - definition, 1
  - radiation exposure, 2

## CE

- label location, 4
- mark, 6

- Closed loop control 3-9–3-10
  - analog closed loop, 3-9–3-10
  - manual closed loop, 3-9

- Closed Loop Stabilization Kit 2-16, 2-17, A-2–A-4
  - connecting, A-3
  - diagram, A-3
  - introduction, A-2
  - operation, A-4
  - safety precautions, A-2
  - specifications, A-4

- Command signal 3-3–3-4

## Compliance

- EU, 5–6
- EU Directives, 6
- FCC, 5

## Connections

- CL Interconnect cable, A-3
- Power/Control cable, 1-5, 1-6

## Connector pinouts

- C/L connector 3-17
- Laser connector 3-17

## Contact information ix

## Control panel

- illustration, 2-2

## Control signals 3-2–3-4

- Command signal, 3-3–3-4
- Pulse Width Modulation, 3-2–3-3
- tickle pulse, 3-2

## Copyright information vii

## D

# index

## Danger

definition, 1

## Declaration of Conformity 7

## Dimensions

UC-2000 package outline, 3-19

UC-2000 panel mount package outline, 3-20

## E

Enter pushbutton 2-2, 2-5, 2-6, 2-7, 2-8, 2-9, 2-10, 2-11, 2-12, 2-14, 3-7, 3-8, 3-9, 3-10, 3-11

## European Union requirements 5–6

## External control 3-7–3-16

analog closed loop, 3-9–3-10

analog current control, 3-7

analog voltage control, 3-8

closed loop control, 3-9–3-10

Gate control, 3-5–3-6

manual closed loop, 3-9

REMOTE control, 3-11–3-16

## F

## Factory default settings 2-10

## FCC requirements 5

## Firmware screen 2-4

## G

Gate connector 2-3, 2-7, 2-18, 3-5, 3-7, 3-8, 3-9, 3-10, 4-2, A-3, A-4

## Gate input 2-18, 3-5

Gate logic 3-6, 4-2  
setting, 2-7

Gate signal 3-5  
specifications, 3-6

## General specifications

Closed Loop Kit, A-4

UC-2000, 3-18

## H

## Hazard information 1–3

additional laser safety information, 3

general hazards, 1–3

label locations, 4

other hazards, 3

terminology, 1

## I

## Initial start-up 2-5

## Inventory

contents description, 1-2

shipping box contents, 1-2

## L

## Label locations 4

Lase indicator 2-2, 2-5, 2-9, 2-11, 2-14, 4-2

Lase On/Off pushbutton 2-2, 2-5, 2-7, 2-8, 2-9, 2-11, 2-18, 3-6, 3-7, 3-8, 3-9, 3-10, 3-11

Lase on power-up  
setting, 2-8–2-9

## Laser connector 2-3, 3-17

# index

- Laser control 2-14–2-18
  - Gate input, 2-18
  - operating modes, 2-14–2-17
- Laser power
  - setting, 2-14, 2-15, 2-16, 2-17
- Laser safety information 1–7
- LCD display 2-2, 2-4, 3-16
- Local control 2-11–2-12
  
- M
- MAN. CLOSED mode 2-16, 3-4, 3-9,  
A-3, A-4
- Manual closed loop control 2-16, 3-9
- MANUAL mode 2-15, 3-4
- Material Safety Data Sheets 2
- Mounting
  - standard model, 1-4
  - panel mount model, 1-4
  
- O
- Operating mode
  - selection, 2-14–2-17
- Operation
  - Closed Loop Stabilization Kit, A-4
  - UC-2000, 2-15
  
- P
- Package outline dimensions 3-19–3-20
- Panel mount model 1-4
- Power/Control cable 1-2, 1-5, 1-6,  
2-3, 2-9
- Pulse Width Modulation 3-2–3-3
- PWM Adj Knob 2-2, 2-5, 2-7, 2-11, 2  
-12, 2-15,  
2-16, 3-2, 3-4, 3-9, 3-11
- PWM control
  - see External control
- PWM frequency
  - setting, 2-6
- PWM percentage
  - setting maximum, 2-8
  
- R
- Rear panel
  - illustration, 2-3
- REMOTE commands, 3-13–3-16
  - lase commands, 3-14
  - mode commands, 3-14
  - PWM (SET) percentage command,  
3-15
  - setup commands, 3-15
  - status command, 3-16
- REMOTE control 2-12–2-13, 3-4, 3-5,  
3-11–3-16
  
- S
- Safety precautions
  - Closed Loop Kit, A-2
  - laser, 1, 2, 3, 2-5, 2-9, 2-12, 3-14
- Save and exit 2-10
- Select pushbutton 2-2, 2-5, 2-6, 2-7,  
2-8, 2-9, 2-10, 2-11, 2-12,

# index

2-14, 3-7, 3-8, 3-9, 3-10, 3-11

Serial cable

diagram, 3-12

Serial Port connector 2-3, 2-14, 3-11

host configuration, 3-13

pin assignments, 3-12

Setup mode 2-6–2-10

Setup screens 2-6

Specifications

analog current, 3-7

analog voltage, 3-8

ANV closed loop, 3-10

Closed Loop Kit, A-4

Command signal, 3-4

Gate input, 3-6

UC-2000, 3-18

Standby mode 2-14

Start-up screen 2-4

## T

Tickle pulse 3-2

Trademark information vii

Troubleshooting 4-2–4-3

## U

UC-2000

features, 1-3

general specifications, 3-18

local control, 2-11–2-12

package outline dimensions, 3-19

panel mount model, 1-4

panel mount outline dimensions, 3-20

REMOTE control, 2-12–2-13

setup, 2-6–2-10

troubleshooting, 4-2–4-3

## W

Wall plug transformer 1-2, 1-5

Warning

accidental exposure, 2-12, 3-14

accidental operation, 2-9

air contaminants, 2

definition, 1

laser radiation, 1

personal injury, A-2

protective eyewear, 1, 2-5, A-2

Warranty information viii