

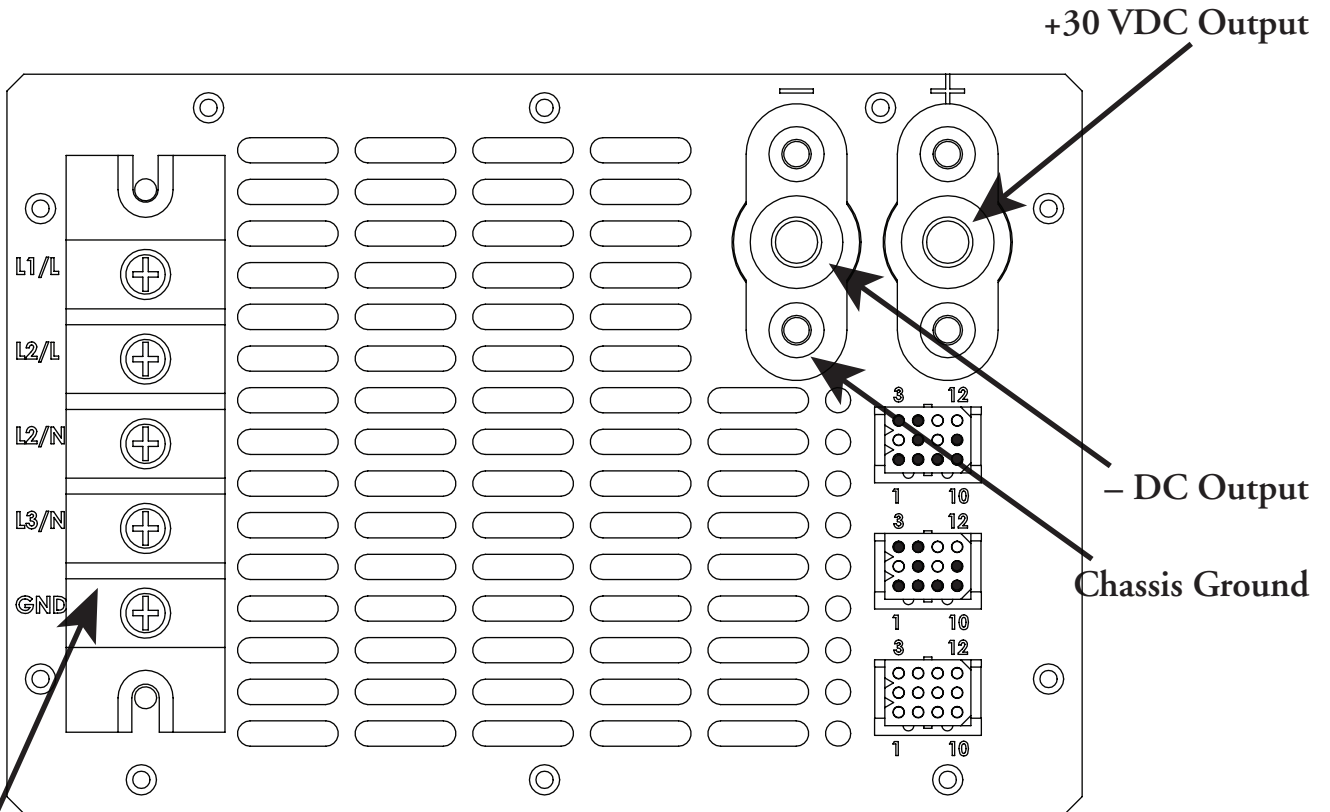

SYNRAD PS-100 DC Power Supply
(Arrow Electronics VAD611132)
With 2 each FXP1500-32G AC-DC Front-End Modules



AC Input
3Ø 105–264 VAC (Recommended)
or 1Ø 208–264 VAC

AC Input Connections:
(See next page for AC connection details)

DC Output Connections:

- * Connect DC Positive (red cable) to Positive (+) 30 VDC terminal.
- * Connect DC Return (black cable) to Negative (–) terminal.
- * If required, connect DC Ground (green wire) to the screw at Chassis Ground.

Rev 6 / 10 Jan 2017
P/N 900-20174-01

Important Note: This supply requires a 4-wire (plus ground) AC input connection for either three-phase (3Ø) or single-phase (1Ø) operation.

AC Input Connections:

Three-phase (3Ø) RECOMMENDED

V = 105–264 VAC, 25 A, 3Ø circuit (230 V/15 A Nominal)

- * Connect Phase 1 to input terminal labeled “L1/L”.
- * Connect Phase 2 to input terminals labeled “L2/L” **and** “L2/N”.
- * Connect Phase 3 to input terminal labeled “L3/N”
- * Attach AC safety ground (earth) to terminal labeled “GND”.

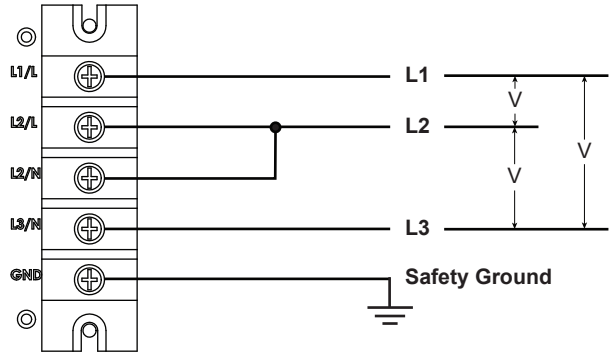

AC Input Connections:

One single-phase (1Ø) circuit

V = one 208–264 VAC, 30 A, 1Ø circuit (230 V/20 A Nominal)

- * Connect hot lead H1 to input terminal labeled “L1/L”.
- * Jumper input terminal “L1/L” to input terminal “L2/L”.
- * Connect hot lead H2 to input terminal labeled “L2/N”.
- * Jumper input terminal “L2/N” to input terminal “L3/N”.
- * The neutral (white) lead is not used.
- * Attach AC safety ground (earth) to terminal labeled “GND”.

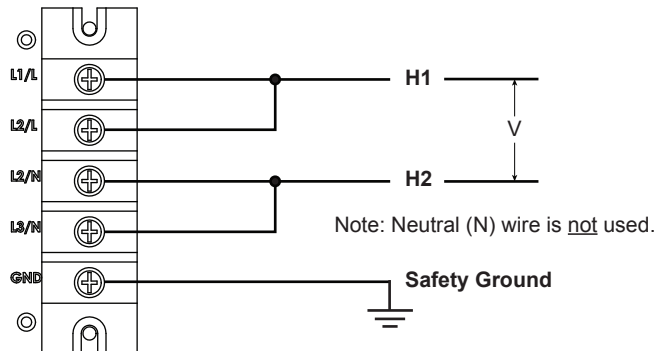

AC Input Connections:

Two individual single-phase (1Ø) circuits

V1/V2 = two 120–264 VAC, 20 A, 1Ø circuits (120 V/20 A Nominal x2)

- * Connect Hot lead H1 to input terminal labeled “L1/L”.
- * Connect Neutral lead N1 to input terminal labeled “L2/N”
- * Connect Hot lead H2 to input terminal labeled “L2/L”.
- * Connect Neutral lead N2 to input terminal labeled “L3/N”
- * Attach AC safety grounds (earth) to terminal labeled “GND”.

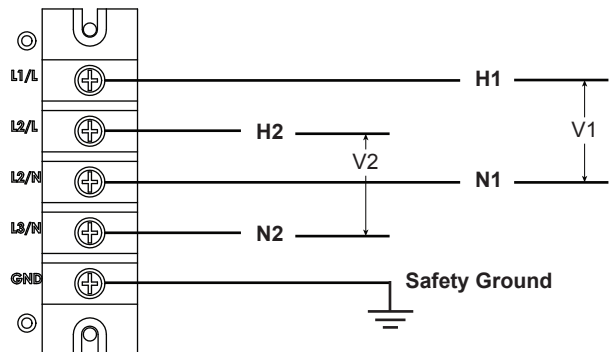

BOTTOM VIEW

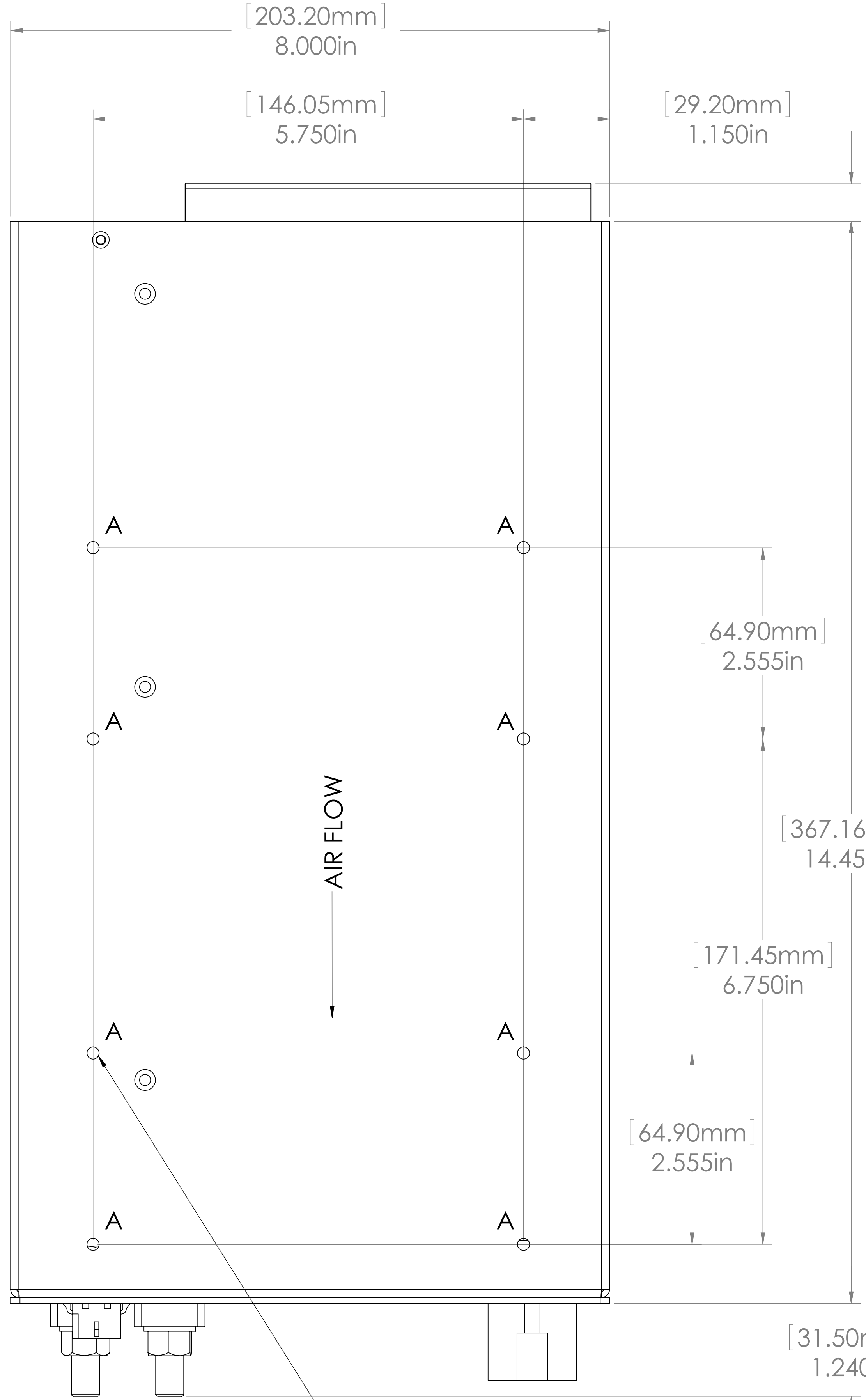

AIR FLOW
↓

Mounting Threaded Holes #8-32
Max. Penetration 0.15"; Torque 5.25 in-lbs
8 Places marked "A"

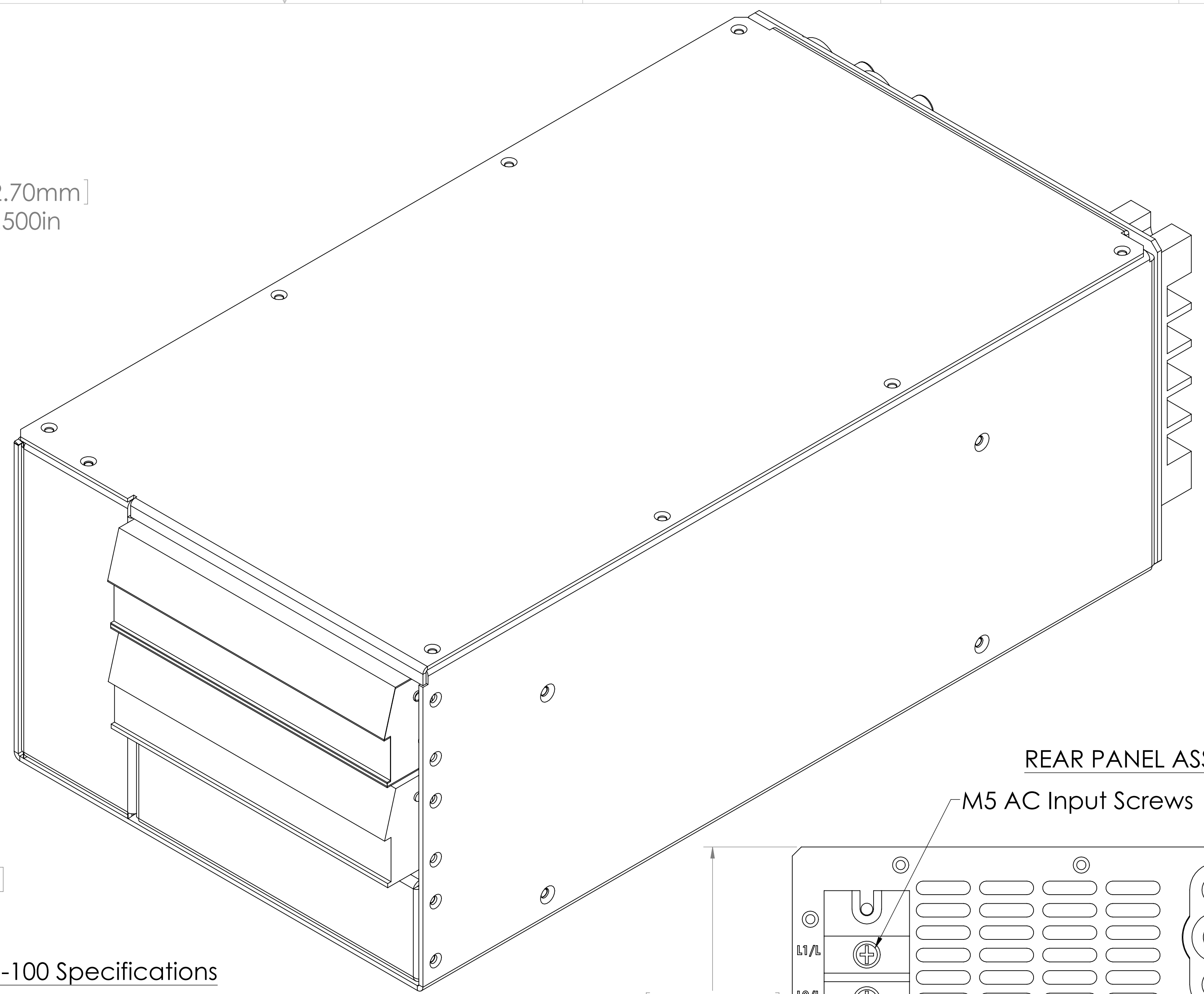

REAR PANEL ASSY.

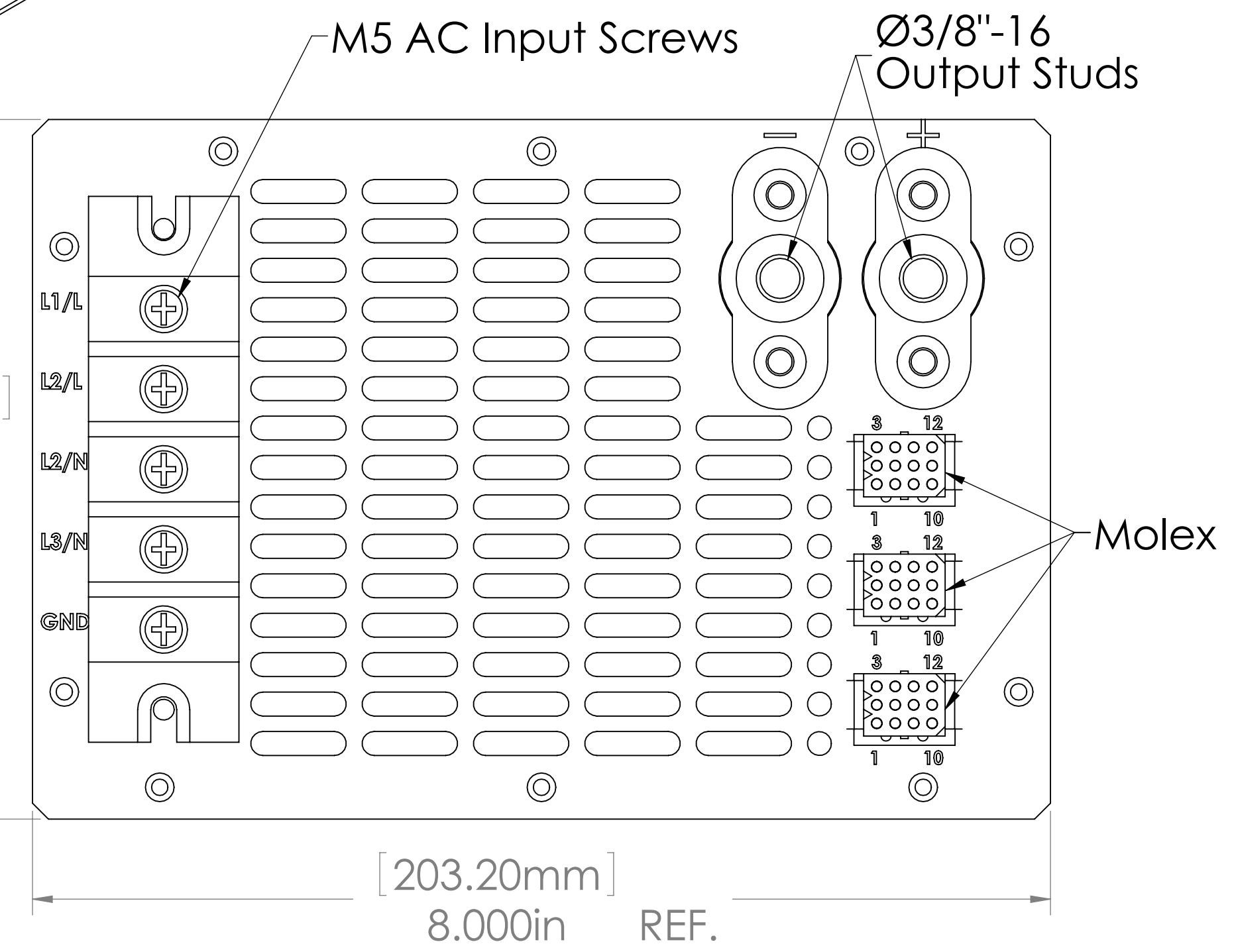

DC-100 Specifications

- 30V / 93.8A - 3000W
- Single or Three Phase AC Input
- 85-264 VAC Input
- 0-50°C 100 Load (0-70°C 50% Load)
- Over Temperature, Over Voltage and Over Current Protection
- Status LEDs: AC-OK, DC-OK and Over Temperature Fail
- Remote Voltage Sense Lines
- Remote Inhibit and Status Signals
- Inrush Current Limiting NTCs
- 2 FXP1500-32S202G Power Supplies

CONTROL SIGNAL PIN OUT	
MOLEX PIN	SIGNAL
1	V Sense +
2	n.c.
3	DC Fail
4	V Sense - & Logic Ground
5	AC Fail
6	Over Temp
7	Aux +5V
8	n.c.
9	n.c.
10	Aux GND
11	Output Inhibit
12	n.c.

PROPRIETARY AND CONFIDENTIAL NOTICE:
THE DESIGN AND RELATED INFORMATION CONTAINED HEREIN AND/OR ATTACHED IS THE SOLE PROPERTY OF ARROW ELECTRONICS. THE DISCLOSURE OF THIS INFORMATION DOES NOT CONSTITUTE THE RELEASE OF ANY PROPRIETARY RIGHTS THEREIN. PERMISSION TO REPRODUCE THIS INFORMATION OR THE PRODUCTS DISCLOSED HEREIN AND/OR ATTACHED MUST BE OBTAINED IN WRITING FROM ARROW ELECTRONICS.

UNLESS OTHERWISE SPECIFIED: DO NOT SCALE DRAWING DIMENSIONS ARE IN INCHES TOLERANCES: FRACTIONAL: ±1/64 ANGULAR: ±.5 BEND ±.015 .XX ±.01 .XXX ±.005	NAME	DATE	ARROW ELECTRONICS, INC.
	V.NGUYEN	8/2/10	
INTERPRET GEOMETRIC TOLERANCING PER: ASME Y14.5M-1994	CHECKED	-	TITLE: DC-100 30V @ 93.8A, 3000W SYNRAD SYSTEMS
	ENGR	-	
MATERIAL SEE BOM	MFG	-	SIZE DWG. NO. REV D VAD611132 A
	Q.A.	-	
FINISH SEE BOM	THIRD ANGLE PROJECTION	WEIGHT: 0.358 LB.	SCALE: 4:1 SHEET 1 OF 1

PS-100 12-Pin Molex Connector Pin Out

Pin #	Signal Name	Description	Vmax Imax	Normal Operation	Fault Condition
1	V Sense + input ¹	Leave open or connect to V+ at the load.	dV <3 Vpp 30 mA	n/a	n/a
2	n.c.				
3	DC Fail output ²		15 V 20 mA	Low State (<0.4 V)	High State (Pull Up)
4	V Sense – input ³ / Logic Ground	Leave open or connect to V– at the load / Logic Ground (return) for DC Fail, AC Fail, and Over Temp outputs.	dV <3 Vpp 30 mA	n/a	n/a
5	AC Fail output ²		15 V 20 mA	Low State (<0.4 V)	High State (Pull Up)
6	Over Temp output ⁴		15 V 20 mA	High State (Pull Up)	Low State (<0.4 V)
7	Aux +5V output	Isolated +5V output. Reference to Pin 10, Aux Ground.		n/a	n/a
8	n.c.				
9	n.c.				
10	Aux Ground	Isolated Aux Ground (return) for Aux +5V output.		n/a	n/a
11	Output Inhibit input ⁵	DC output enabled when open or pulled Low. Connect this input to Pin 7, Aux +5V, to inhibit DC output.	10 V 3.5 mA	n/a	n/a
12	n.c.				

Connection Notes:

Each of the two power supply modules has its own I/O connector.

- This pin is internally connected to V+ through 100 Ohm resistor. For remote sensing, connect Pin 1 (V sense +) on connector 1 to Pin 1 on connector 2 and then connect to positive (+) side at load.
- Module-specific output. Open-Collector output protected by 16 V Zener diode and 10 Ohm resistor in series. These output signals are pulled Low during normal operation and are floating during a fault condition. Use a user-supplied external 500 Ohm resistor to pull High to 5V level for fault annunciation. Output rated for 15 V, 20 mA maximum.
- Pin 4 (V sense – signal) is internally connected to V– through 100 Ohm resistor. For remote sensing, connect Pin 4 (V sense –) on connector 1 to Pin 4 on connector 2 and then connect to negative (–) side at load.
- Module-specific output. Open-Collector output protected by 16 V Zener diode and 10 Ohm resistor in series. This output signal is floating during normal operation and pulled Low during a fault condition. Use a user-supplied external 500 Ohm resistor to pull Low from 5V level for fault annunciation. Output rated for 15 V, 20 mA maximum.
- Module-specific input. DC output enabled when input open or pulled Low (<0.8 V). Connect this input to Pin 7, Aux +5V, to inhibit DC output (> 2.0 V). 2.5 mA of current will pull input High and disable DC output.

The mating connector for the 12-pin Molex connector is Molex 03-06-2122. The required contact pins are Molex 02-06-2103.



Applications

- Test & measurement, RF amplifiers & transmitters, factory automation, semiconductor & LD-MOS based equipment, and other distributed power applications

Features

- 28 VDC, 32 VDC and 36VDC output voltage preset via VID pins
- Margining via I²C
- Active current/load sharing
- Wide input voltage range 85-264 VAC
- Highly-efficient topology yields 89% at 230 VAC
- 1U high: 5.6" x 1.6" x 12" cassette
- Input fuse protected
- I²C interface status and control
- High density design: 13.4 W/in³
- Up to 4500 W in a 1U-high, 19-inch wide rack
- Standby voltage 5 VDC/1A
- Adjustable output voltage
- Overtemperature, output overvoltage, and output overcurrent protection
- ORing circuit for true redundant operation
- Status LEDs: AC OK, DC OK, Fan Fail/Overtemperature Fail
- Auto select power limits ¹



The FXR-3-32G shelf provides capability to parallel up to three FXP1500-32G PSUs in a 19" rack, see rack section (below) for power shelf details.

Description

The FXP1500-32G is a 1500 watt, power factor corrected (PFC) front-end, which provides a user-adjustable 32 VDC (26-38 VDC range) main output for test & measurement, RF amplifiers and transmitters, factory automation, semiconductor equipment, and other distributed power applications. The FXP1500-32G provides for true hot-swap with AC and DC connections at the rear of the model and can be used for redundant system applications. Its very small dimensions allow configuration of up to three units in a 1U rack (up to 4500 W). The highly-efficient thermal design with internal fan cooling permits its use in wide operating voltage and temperature ranges to provide very high reliability.

Status information is provided with front panel LEDs, logic signals, and via the I²C management interface. In addition, the I²C bus can enable the power supply, control the fan speed, adjust the output voltage, and set the output current limit.

The FXP1500-32G meets international safety standards and displays the CE-Mark for the European Low Voltage Directive (LVD).

Model Selection

Model	Input voltage VAC auto selected ¹	Output 1		Output 2		Rated power W
		$V_{o\ nom}$ VDC	$I_{o\ max}$ ADC	$V_{o\ nom}$ VDC	$I_{o\ max}$ ADC	
FXP1500-32G	85 – 264	32	46.9	5	1	1505 ³

¹ The available output power is automatically adjusted depending on the input voltage.

² 1U standard rack FXR-3-32G for FXP1500-32G is available from Power-One.

³ Automatic derating of main output below 108 VAC to: $I_{o\ max} = 37.5\ A$ (1200 W).

Absolute Maximum Ratings

Stress in excess of the absolute maximum ratings may cause performance degradation, adversely effect long-term reliability, or cause permanent damage to the converter.

Parameter	Conditions/description	Min	Max	Unit
Input voltage	Continuous Transient, 60 ms max.		264 300	VAC VAC
Operating ambient temperature	$V_{i\ min} - V_{i\ max}$, $I_{o\ nom}$, cooling by internal fan 100 % load from 0 to 50°C linear derating to 50% load from 50°C to 70°C	0	70	°C °C
Storage temperature	Non-Operating	-40	85	°C

Environmental, Mechanical, & Reliability Specifications

Parameter	Conditions/description	Min	Nom	Max	Unit
Altitude	Operating Non-Operating			10 k 40 k	ASL Ft. ASL Ft.
Relative humidity, non-condensing	Operating	10		90	% RH
	Storage	5		95	% RH
Temperature coefficient	0 °C to 70 °C (after 15 min warm-up)			0.02	%/K
Shock	IEC/EN 60068-2-27, 11 ms			40	g_{pk}
Sinusoidal vibration	IEC/EN 60068-2-6 2-8 Hz 8-200 Hz 200-500 Hz		7.5		mil
			2		g_{pk}
			4		g_{pk}
Random vibration	10-2000 Hz		6.15		g_{rms}
MTBF	Calculated per Bellcore (SR-332, Issue 1): GB 25°C	230			kh
	Demonstrated	250			kh

Safety Specifications

Maximum electric strength testing is performed in the factory according to EN 550116, IEC/EN 60950, and UL 60950. Input-to-output electric strength tests should not be repeated in the field. Power-One will not honor any warranty claims resulting from electric strength field tests.

Parameter	Conditions/description	Min	Nom	Max	Unit
Agency approvals	UL60950, (UL) CSA 60950 (cUL), EN 60950(TÜV), CE Mark for LVD				
Insulation safety rating	Input to case Input to output Output to case	Basic Reinforced Functional			
Electric strength test voltage	Input to case Input to output Output to case Output 1 to output 2	2.12 Note ¹ 0.1 0.1			kVDC kVDC kVDC kVDC

¹ Subassemblies are pre-tested with 4.2 kVDC in accordance with EN50116 and IEC/EN60950.

EMC Specification

Parameter	Description	Criterion
Electrostatic discharge	IEC/EN 61000-4-2, level 4 (contact/air)	8/15 kV, Performance criterion B
Electromagnetic field	IEC/EN 61000-4-3, level 3	10 V/m, Performance criterion A
Electrical fast transients/burst	IEC/EN 61000-4-4, level 3 (L/L, L/E)	2 / 1 kV, Performance criterion B
Surge	IEC/EN 61000-4-5, level 3 (L/L, L/E)	1 / 2 kV, Performance criterion B
Voltage dips and interruptions	IEC/EN 61000-4-11 Dip 30 %, 100 ms Dip 30 %, 200 ms Dip 60 %, 20 ms Dip 60 %, 100 ms Dip > 95 %, 20 ms Dip > 95 %, 100 ms	Performance criterion A Performance criterion B Performance criterion A Performance criterion B Performance criterion A Performance criterion B
RF conducted immunity	IEC/EN 61000-4-6	10 VAC, AM 80 %, 1 kHz Performance criterion A
Emissions conducted	CISPR 22/EN 55022/EN 61204	Class B
Emissions radiated	CISPR 22/EN 55022/EN 61204	Class A
Harmonics	IEC/EN 61000-3-2	Class B
Voltage fluctuation and flicker	IEC/EN 61000-3-3	Pass
Voltage sag	SEMI F47-0200 (High Line 230V)	Pass

Input Specification

Specification is valid for input voltage, load, and temperature ranges, unless otherwise stated.

Parameter	Conditions/description	Min	Nom	Max	Unit
Input voltage		85	230	264	VAC
Input frequency		47	50/60	63	Hz
Turn-on input voltage	Ramping up	79	-	85	VAC
Turn-off input voltage	Ramping down	70	-	78	VAC
Inrush current limitation	115/230 VAC acc. ETS 300 132-1 < 100 ms			50	A _{pk}
Hold-up time	After last AC line peak, V _i = 230 VAC, P _{o nom}	20			ms
Power factor	V _{i nom} , I _{o nom}	0.95			W/VA
Efficiency	V _i = 230 VAC, V _{o nom} , I _{o nom} , T _c =25°C	89	89.5		%
Max input current				20	A _{rms}

Output Specification

Specification is valid for input voltage, load, and temperature ranges, unless otherwise stated.

Parameter	Conditions/Description	Min	Nom	Max	Units
Total output voltage range	Adjustable via T4, T5 pins & I ² C	26		38	VDC
Output voltage set point	Adjustable via T4, T5 pins (LL=28V, LH=HL=32V, HH=36V)		28 32 36		VDC VDC VDC
Output voltage trimming	Adjustable via I ² C from any set point. Note: all changes to V _{o1} made via I ² C are volatile and are lost upon power cycling the PSU	-2		+2	VDC
Overvoltage protection latching	28V set point 32V set point 36V set point		35 40 45		VDC VDC VDC
Nominal current output 1	I _{o1 nom} @ V _i = 105 VAC – 264 VAC, P _o 1.5 kW 28V set point 32V set point 36V set point I _{o1 nom} @ V _i = 85 VAC – 105 VAC, P _o 1.2 kW 28V set point 32V set point 36V set point		46.9 46.9 41.7 42.9 37.5 33.4		ADC ADC ADC ADC ADC ADC
Nominal current output 2	I _{o2 nom} @ V _i = 85 VAC – 265 VAC, P _o 5 W		1.0		ADC
Current limit output 1	I _{o1 max} @ V _i = 105 VAC – 264 VAC high droop hic-cup I _{o1 max} @ V _i = 85 VAC – 105 VAC high droop hic-cup		48.8 50.8 39.0 41.0		ADC ADC ADC ADC
Current limit output 2	I _{o2 max} @ V _i = 85 VAC – 265 VAC		1.3		ADC
Static line regulation output 1	V _{i min} - V _{i max} , 50 % I _{o nom}	-0.5		0.5	% V _{o nom}
Static load regulation output 1 (droop characteristic)	V _i = 230 V, 0-100 % I _{o nom} V _o : full load (46.9 ADC) to no load	31.68 -1.0	32	13.6 32.32 +1.0	mV/A VDC % V _{o nom}
Dynamic load regulation	Load change 1% ↔ 100% I _{o nom} , dI _o /dt = 1 A/μs Voltage deviation (droop + over- or undershoot) Max. recovery time to within 1 % of V _{o1 nom}	-4		+4 2000	% V _{o nom} μs
Start-up time	Time required for output within regulation after initial application of AC-input (V _{i nom} , I _{o nom}) after removal of inhibit (V _{i nom} , I _{o nom})		100	1.5	s ms
Output voltage ripple and noise	V _{i nom} , I _{o nom} , 20 MHz bandwidth V _{o1} V _{o2}			320 50	mV _{pp} mV _{pp}
Remote sense	Total compensation for cable losses			500	mV
Active current share	Difference in current between two units for V _{o1} above 10 % load. Active current share pin with its 1kΩ internal impedance enables control of output voltage. Voltage on this pin is proportional to output current, 2V at I _{o1 nom}			5	ADC

Controls and Indicators

Specification is valid for input voltage, load, and temperature ranges, unless otherwise stated.

Parameter	Type ¹	Conditions/Description
Visual Status Indication	FP	LED indicators ² : <ul style="list-style-type: none"> • DC OK (green) • AC OK (green) • Fan fail & Over-temperature (amber)
I ² C communication bus	OC[S1, S2]	<ul style="list-style-type: none"> • Monitors alarm functions and allows control of specific parameters. • Uses standard Philips two wire bus (SCL and SDA signal lines)
I ² C communication bus addressing	OC[T1-T3]	Three lines provide up to 8 separate PSU I ² C addresses
PS present pin	OC[U3]	<ul style="list-style-type: none"> • Used by system to indicate a PSU is installed in a system shelf • Contact closure to logic ground (internal pull-down resistor of 1 kΩ)
PS main output remote shutdown	OC[R1]	<ul style="list-style-type: none"> • TTL compatible signal, inhibited when open contact, high or at TTL logic "1" • Signal referenced to logic return (LRTN)
	FP	Two position switch in series with OC signal (logical AND) allows local enable/disable; "0" Position => PS disabled; "1" Position => PS Enabled
Power supply OK	I ² C	AC OK & DC OK & no overcurrent & no over-temperature & fans working
DC current fail	I ² C	Reports over-current condition on main output, I _{O1}
AC fail / Power down warning	OC[U2] & I ² C	<p>Provides a warning that the input power has failed at least 5 ms before the output falls out of regulation (<90% V_{O1} set).</p> <ul style="list-style-type: none"> • Open collector signal with 20 mA pull-down capability, referenced to logic return (LRTN). • AC fail will go high or open during power fail condition and will go low when input is within the operating range. • A Power Fail warning will turn off the front panel green AC OK LED.
DC fail / Output voltage fault	OC[U4] & I ² C	<p>Internal under-voltage and overvoltage supervision of V_{O1}.</p> <ul style="list-style-type: none"> • Open collector signal with 20 mA pull-down capability, referenced to logic return (LRTN). • DC fail will go high or open if Vo1 < 90% or V_{O1}> 110% of V_{O1} set, measured in front of the ORING FETs. • Green LED on the front panel indicates normal operation; LED will flash if in parallel operation V_{O1} is OK, but the unit is disabled.
Critical temperature Warning/Fan Fail	OC[U1] & I ² C	<p>Indicates the PSU operating temperature has reached [T_{shut-down} – 10K] Indicates if the unit is in over-temperature shutdown.</p> <ul style="list-style-type: none"> • Open collector signal with 20 mA pull-down capability, referenced to logic return (LRTN). • The OC-output will go low 100 ms before an over-temperature condition shuts down the unit. • An amber LED on the front panel indicates over-temperature or fan fail.
DC voltage monitoring	I ² C	Monitors the main output voltage, V _{O1} , seen at the output connector Accuracy is ±1% over setting range and temperature.
DC current monitoring	I ² C	Monitors the output current I _{O1} : Accuracy ± 1% over the load range.
Active current share interconnect	OC[R4]	Line must be connected to all paralleled PSUs to allow active current share functionality between units
V _{O1} presets	OC[T4,T5]	<p>Output voltage is preset per programming of T4, T5</p> <ul style="list-style-type: none"> • T4/T5 = LOW / LOW => V_{O1}=28VDC • T4/T5 = LOW / HIGH = HIGH / LOW => V_{O1}=32VDC • T4/T5 = HIGH / HIGH => V_{O1}=36VDC
V _{O1} voltage trimming (margining)	I ² C	<p>Output voltage trimming Vo1: ±2 VDC</p> <p>Setting accuracy over I²C: ± 50mV at V_{O1}nom, ± 150 mV over setting range</p>
Fan speed control	I ² C	Two fan speed levels automatically set depending on the internal temperature. The fan speed can be set to full speed or automatic control via I ² C command.
Fan OK/FAIL	OC[U1] & I ² C	Indicates if the cooling fans are operating or have failed.
Synchronized startup pin	OC[R5]	Overcurrent signal which can be used for synchronous startup of units in parallel or to recover from an overload condition.

¹ Abbreviations used:

- **OC[#]** => Hardwired signal accessible at PSU output connector, with pin number reference
- **FP** => Provided by devices located on PSU Front panel
- **I²C** => Signal provided over I²C communication system; detailed I²C information is available from the specific model's I²C Manual found on the Power-One web site.

² See LED Function table for further details

Output Connector Pinning and Signal Specification

Output Connector Description	OC Pin #	Type	Signal Reference	Low level High level	V max I max
Over-temperature / Fan Fail	U1	OC-output, protected by 16 V Zener diode and a 10Ω resistor in series	LGND	<0.4 V @ 20 mA Pull up	15 V 20 mA
AC Fail / Power down warning	U2			<0.4 V @ 20 mA Pull up	15 V 20 mA
Power Supply Present	U3	1KΩ Resistor connected to logic GND	LGND	Open Pull up	10 V 10 mA
DC Fail / Output voltage fault	U4	OC-output, protected by 16 V Zener diode and a 10Ω resistor in series	LGND	<0.4V @ 20 mA Pull up	15 V 20 mA
Internal ground (INT GND)	U5	Used only for ADDR _x and V _{O1} set. Do not connect the internal grounds in systems with several units.	Connected to V _{O1} - line before the output filter	-	-
ADDR0 I ² C address bus	T1	High = internal 10 KΩ PU to 5V=> Logic 1 Low = connect to INT GND => Logic 0	INT GND	Logic 1 Logic 0	5V 0V
ADDR1 I ² C address bus	T2				
ADDR2 I ² C address bus	T3				
V _{O1} set	T4				
V _{O1} set	T5				
SDA, I ² C serial data line	S1	I ² C compatible signal referenced to logic GND 5 V or 3.3 V logic	LGND	Logic 1 Logic 0	5V 0V
SCL, I ² C serial clock line	S2				
Auxiliary power +5 V	S3	V _{O2+} output, isolated from main output	Aux output is floating	-	-
Auxiliary power +5 VRTN	S4	Aux output return; ground isolated from main output			
Logic ground (LGND)	S5	Internally connected to Aux GND through 10Ω resistor. Wire LGND separately from Aux RTN and main output GND to minimize noise on signals and I ² C bus. Leave open if not used.	-	-	-
Output inhibit R1	R1	PS active when pulled low (DC-DC stage off when left open)	LGND	<0.8 V >2.0 V	10 V 3.5 mA
V sense +	R2	Open or connected to V _{O1+} at the load Internally connected to V _{O1+} via 100 Ω.	-	-	dV<3 V _{pp} 30 mA
V sense -	R3	Open or connected to V _{O1-} at the load Internally connected to V _{O1-} via 100 Ω.	-	-	
Active Current Share	R4	This pin must be interconnected to pin R4 of all other paralleled PSUs for proper operation of active current share function	-	-	2V
Synchronized Startup (for paralleled units)	R5	Open or connected to synch startup circuit	V _{O1} - at the OC		12V 2mA
V _{O1-}	P1, P3, P5	Main output - pins	-	-	-
V _{O1+}	P2, P4, P6	Main output + pins	-	-	-
Input Connector Description	OC Pin #	Type			
Protection Earth	P1	PE			
Phase	P2	L			
Neutral	P3	N			

Protection

Parameter	Conditions/description	Min	Nom	Max	Unit
Input fuse	Not user accessible	25AF			
Inrush current limitation		with NTCs			
Output		No-load, short circuit, and overload proof			
Overvoltage protection latching ¹	Absolute		40		V
Over-temperature protection	Automatic power shutdown at T_C		95		°C

LED Indicator Functionality

Condition	Power Fail (AC OK)	Output Good (DC OK)	Fan Fail and Over - Temperature
Normal Operation	Green	Green	OFF
Power Supply is inhibited	Green	OFF	Amber
Input AC is low	OFF	OFF	Amber
Input AC is low or missing	OFF	OFF	Amber/OFF
Over-temperature	Green	OFF	Amber
Output overload (In regulation)	Green	Green	OFF
Output Overloaded (Out of Regulation)	Green	OFF	OFF
Fan Not running	Green	OFF	Amber
Power Supply Failed	OFF	OFF	OFF/ Amber

Cooling:

To achieve best cooling results sufficient airflow through the unit must be ensured. Do not block or obstruct the airflow at the rear of the unit by placing large components directly at the output connector.



Mechanical Data

Mechanical Data (W, H, D)	5.6" (141.2mm) x 1.6" (40.5mm) x 12" (304.8mm)
---------------------------	--

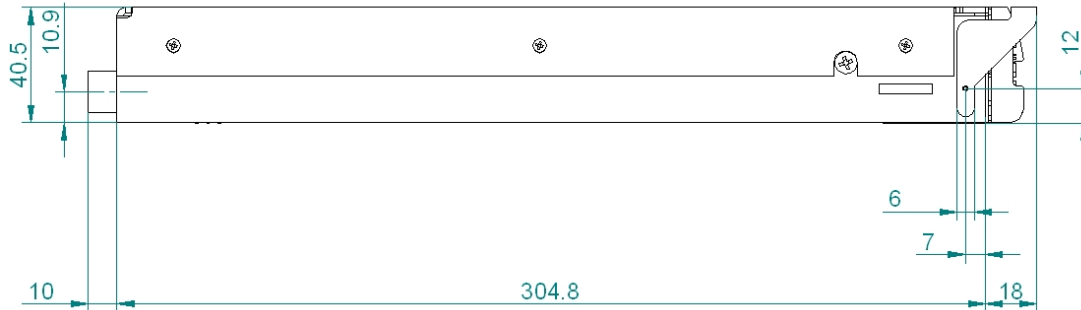

Output Connector FCI part no. 51732-020LF

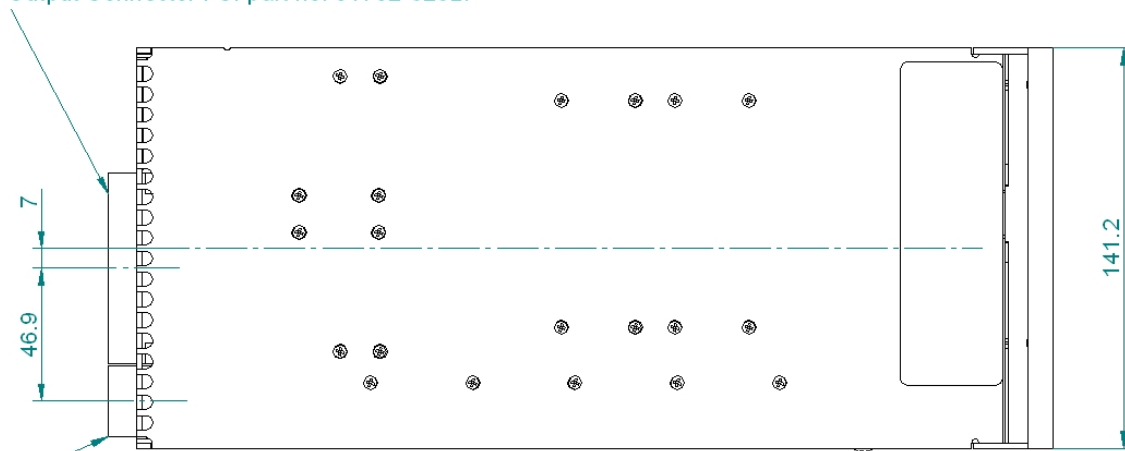

Input Connector FCI part no. 51939-126LF

Input and Output Connector Descriptions

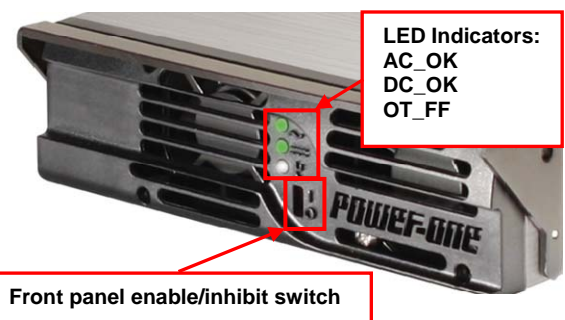
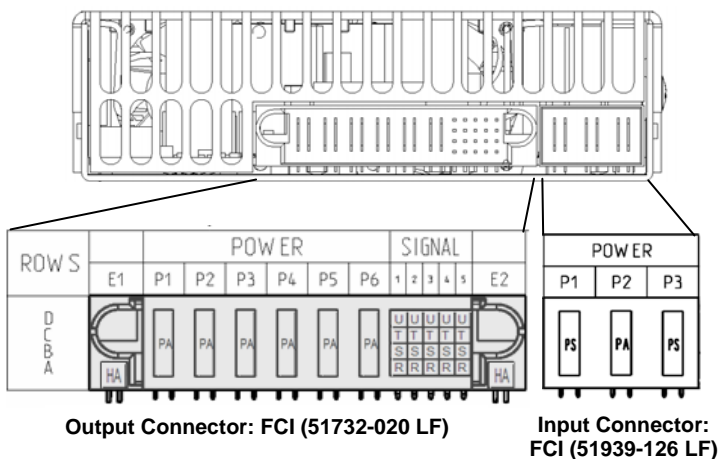

FXP series front bezel showing LED indicators and recessed enable switch

Female ledge connector: Manufacturer: FCI
 Output connector Part No.: 51762-10602000AA LF (Horizontal)
 Output connector Part No.: 51742-10602000AA LF (Vertical)
 Input connector Part No.: 51915-056LF (Horizontal)
 Input connector Part No.: 51940-099LF (Vertical)
 Information on availability under <http://www.stkcheck.com/evs/fcielectronics/fcisearch.asp>