

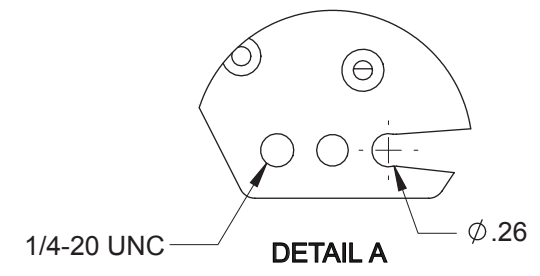

REV	ECO	DATE	DESCRIPTION	DB
A	3581	5-Feb-08	PRODUCTION RELEASE	DMD

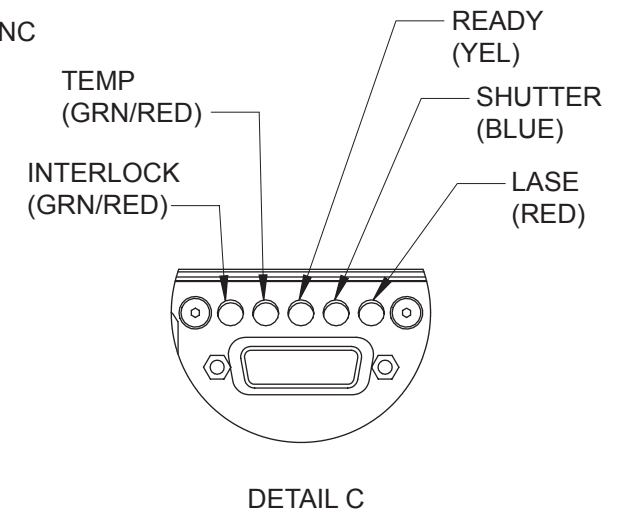
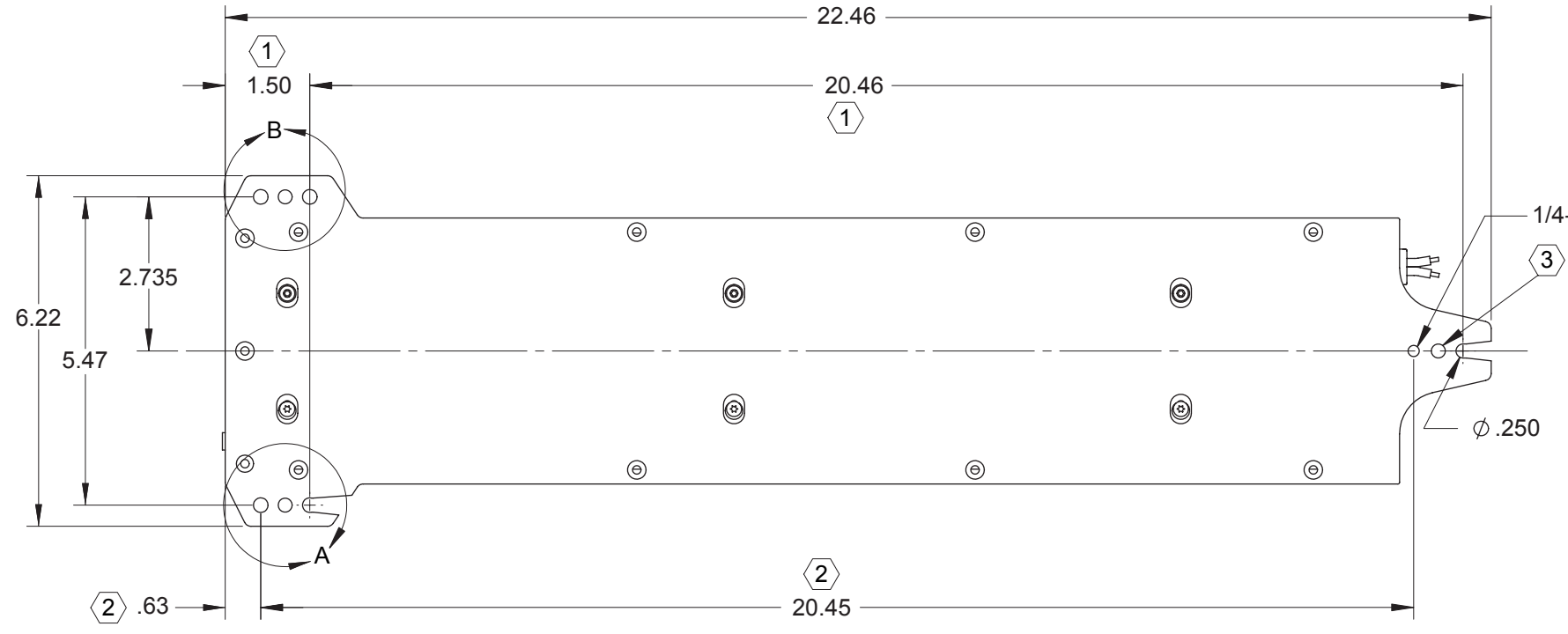
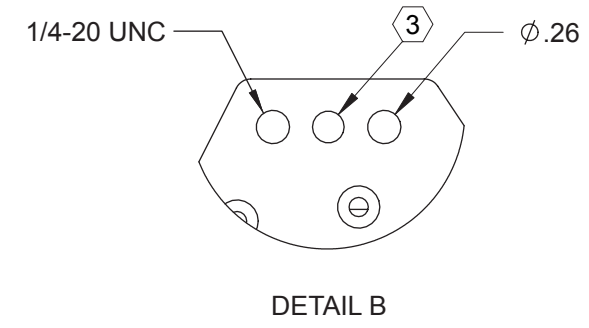
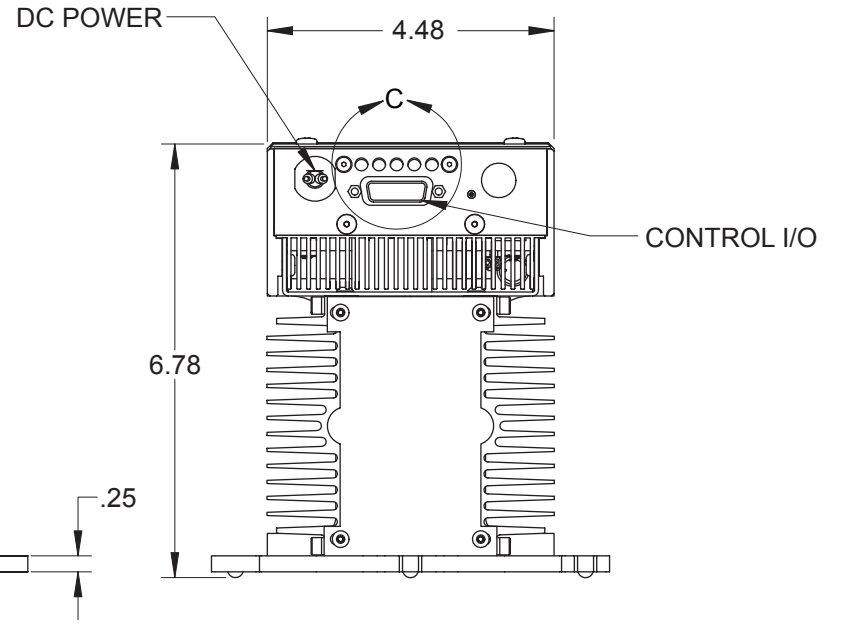
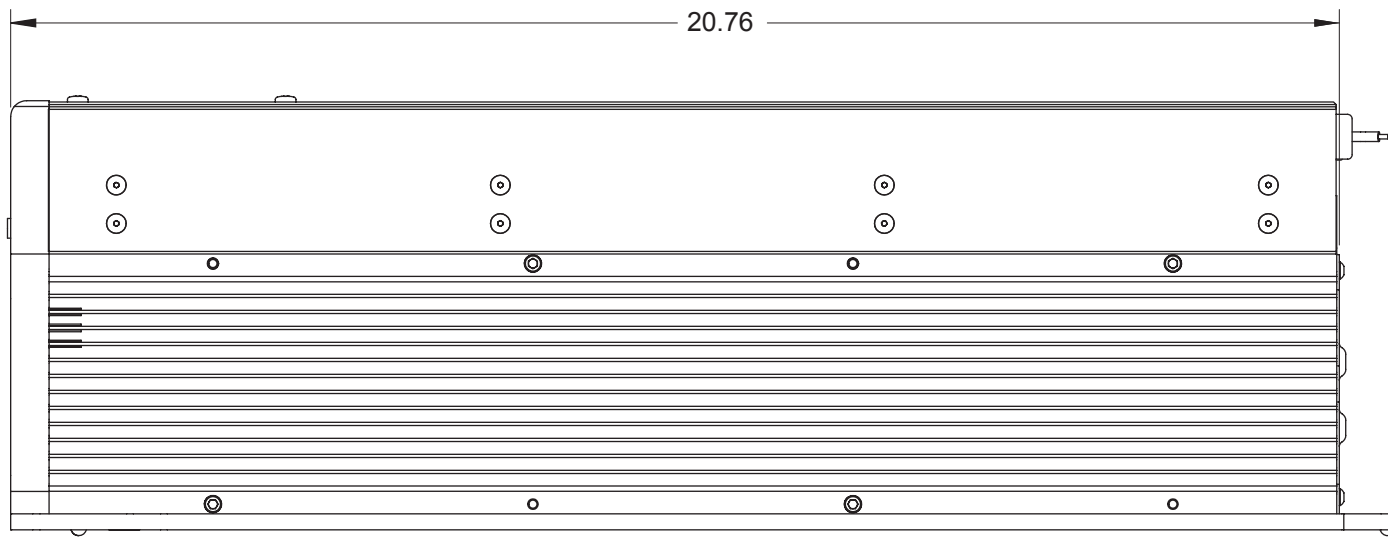
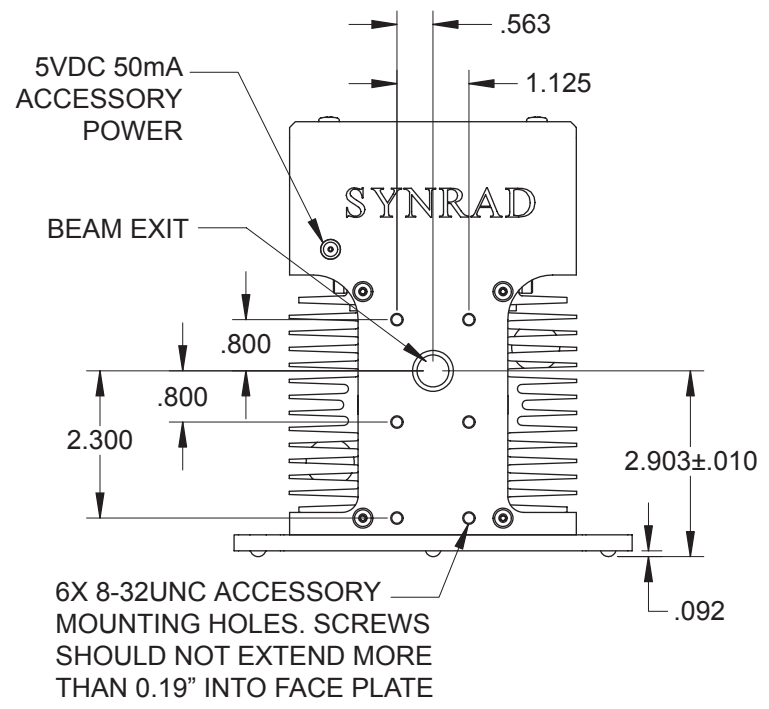

- NOTES:
- ① THIS MOUNTING HOLE PATTERN USED WHEN TOP ACCESS FASTENING DESIRED.
 - ② THIS MOUNTING HOLE PATTERN USED WHEN BOTTOM ACCESS FASTENING DESIRED.
 - ③ HARDENED BALL MOUNTING POINT, 3X (Ø .250 STEEL BALL).

PROPRIETARY THIS DRAWING IS PROPRIETARY TO SYNRAD INC. AND SHALL NOT BE USED OR DISCLOSED IN WHOLE OR IN PART WITHOUT WRITTEN PERMISSION OF SYNRAD INC.		 SYNRAD INC. 4600 Campus Place Mukilteo, WA 98275 Phone: (425)349-3500 Fax: (425)349-3667	
DESCRIPTION: OUTLINE & MOUNTING, AIR COOLED, T70i, OEM			
PART NUMBER: FST70ISAB	DWG/FILE NUMBER: 300-19745-01		
SHEET 1 OF 1	ENG: RLS	DRAWN BY: RLS	DATE: 07-26-07
UNITS: Inches	CATEGORY: I	CHECKED BY:	DATE:
SIZE: B	FINISH CLASS: A	APPROVED BY:	DATE: