

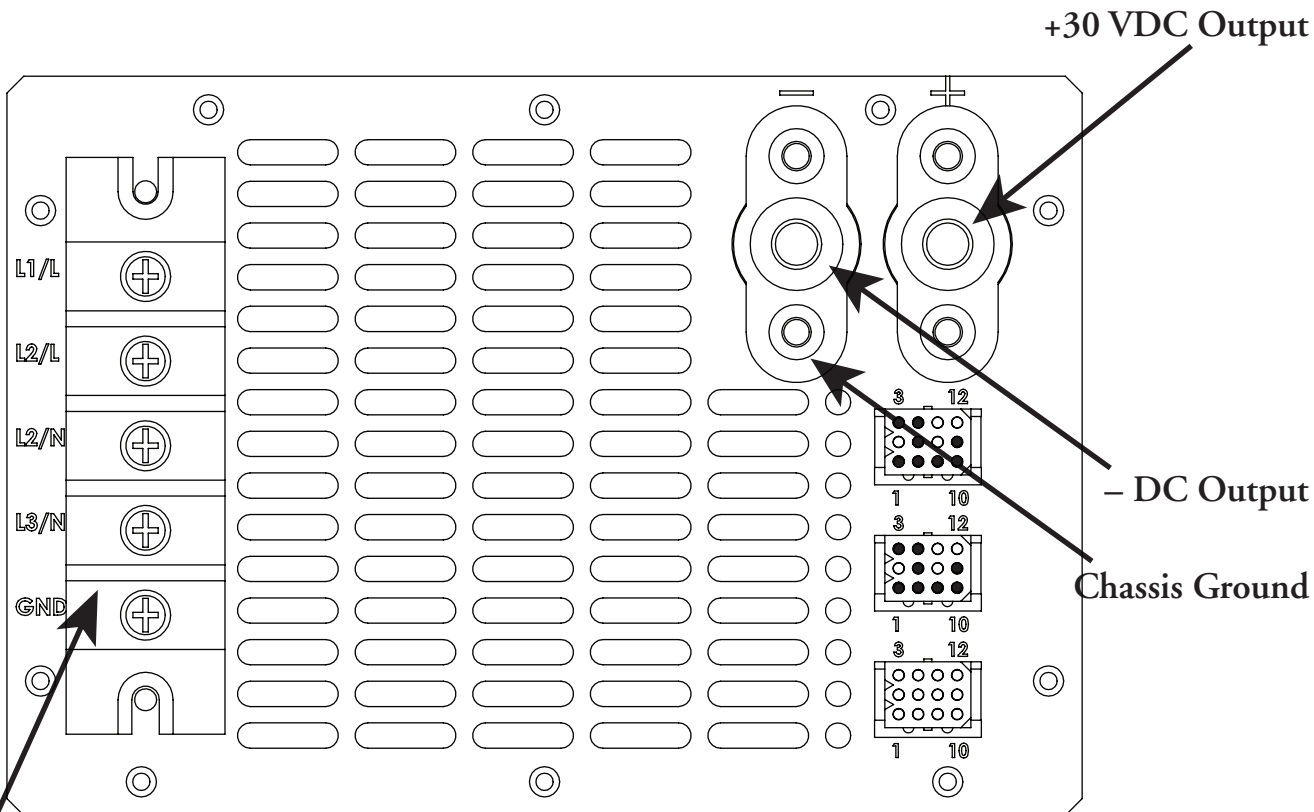

SYNRAD PS-100 DC Power Supply
(Arrow Electronics VAD611132)
With 2 each FXP1500-32G AC-DC Front-End Modules



AC Input
3Ø 105–264 VAC (Recommended)
or 1Ø 208–264 VAC

AC Input Connections:
(See next page for AC connection details)

- DC Output Connections:**
- * Connect DC Positive (red cable) to Positive (+) 30 VDC terminal.
 - * Connect DC Return (black cable) to Negative (–) terminal.
 - * If required, connect DC Ground (green wire) to the screw at Chassis Ground.

Rev 5 / 07 Oct 2011
P/N 900-20174-01

Important Note: This supply requires a 4-wire (plus ground) AC input connection for either three-phase (3Ø) or single-phase (1Ø) operation.

AC Input Connections:

Three-phase (3Ø) RECOMMENDED

V = 105–264 VAC, 25 A, 3Ø circuit (230 V/15 A Nominal)

- * Connect Phase 1 to input terminal labeled “L1/L”.
- * Connect Phase 2 to input terminals labeled “L2/L” **and** “L2/N”.
- * Connect Phase 3 to input terminal labeled “L3/N”
- * Attach AC safety ground (earth) to terminal labeled “GND”.

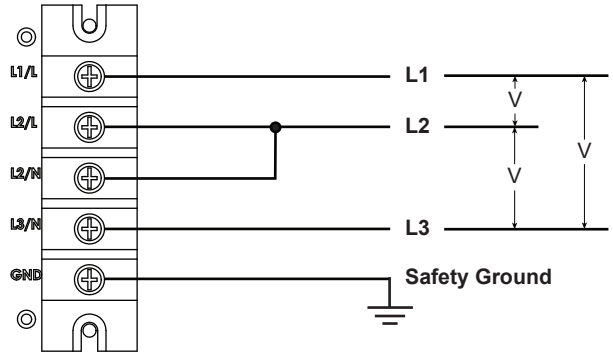

AC Input Connections:

One single-phase (1Ø) circuit

V = one 208–264 VAC, 30 A, 1Ø circuit (230 V/20 A Nominal)

- * Connect hot lead H1 to input terminal labeled “L1/L”.
- * Jumper input terminal “L1/L” to input terminal “L2/L”.
- * Connect hot lead H2 to input terminal labeled “L2/N”.
- * Jumper input terminal “L2/N” to input terminal “L3/N”.
- * The neutral (white) lead is not used.
- * Attach AC safety ground (earth) to terminal labeled “GND”.

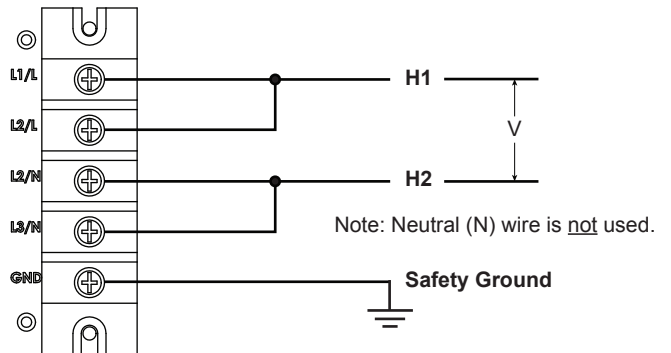

AC Input Connections:

Two individual single-phase (1Ø) circuits

V1/V2 = two 120–264 VAC, 20 A, 1Ø circuits (120 V/20 A Nominal x2)

- * Connect Hot lead H1 to input terminal labeled “L1/L”.
- * Connect Neutral lead N1 to input terminal labeled “L2/N”
- * Connect Hot lead H2 to input terminal labeled “L2/L”.
- * Connect Neutral lead N2 to input terminal labeled “L3/N”
- * Attach AC safety grounds (earth) to terminal labeled “GND”.

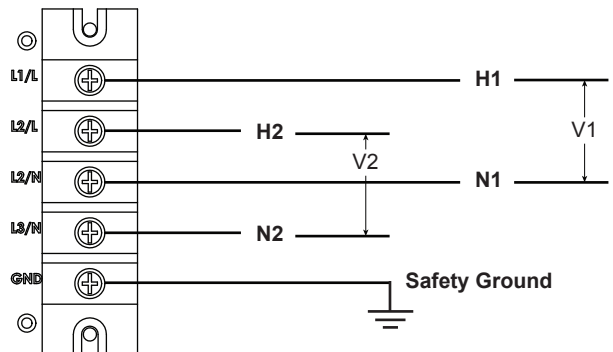

BOTTOM VIEW

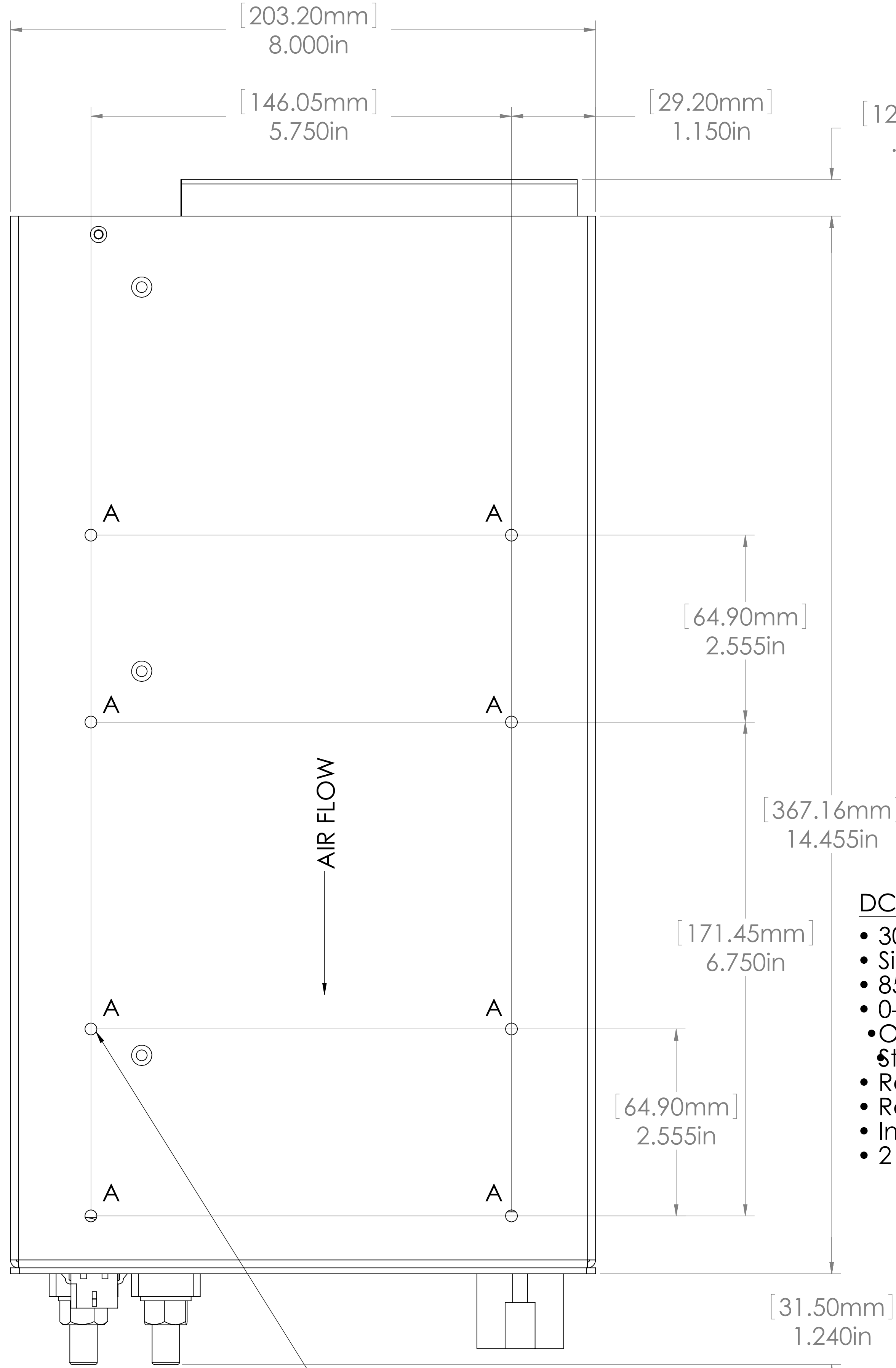

AIR FLOW
↓

Mounting Threaded Holes #8-32
Max. Penetration 0.15"; Torque 5.25 in-lbs
8 Places marked "A"

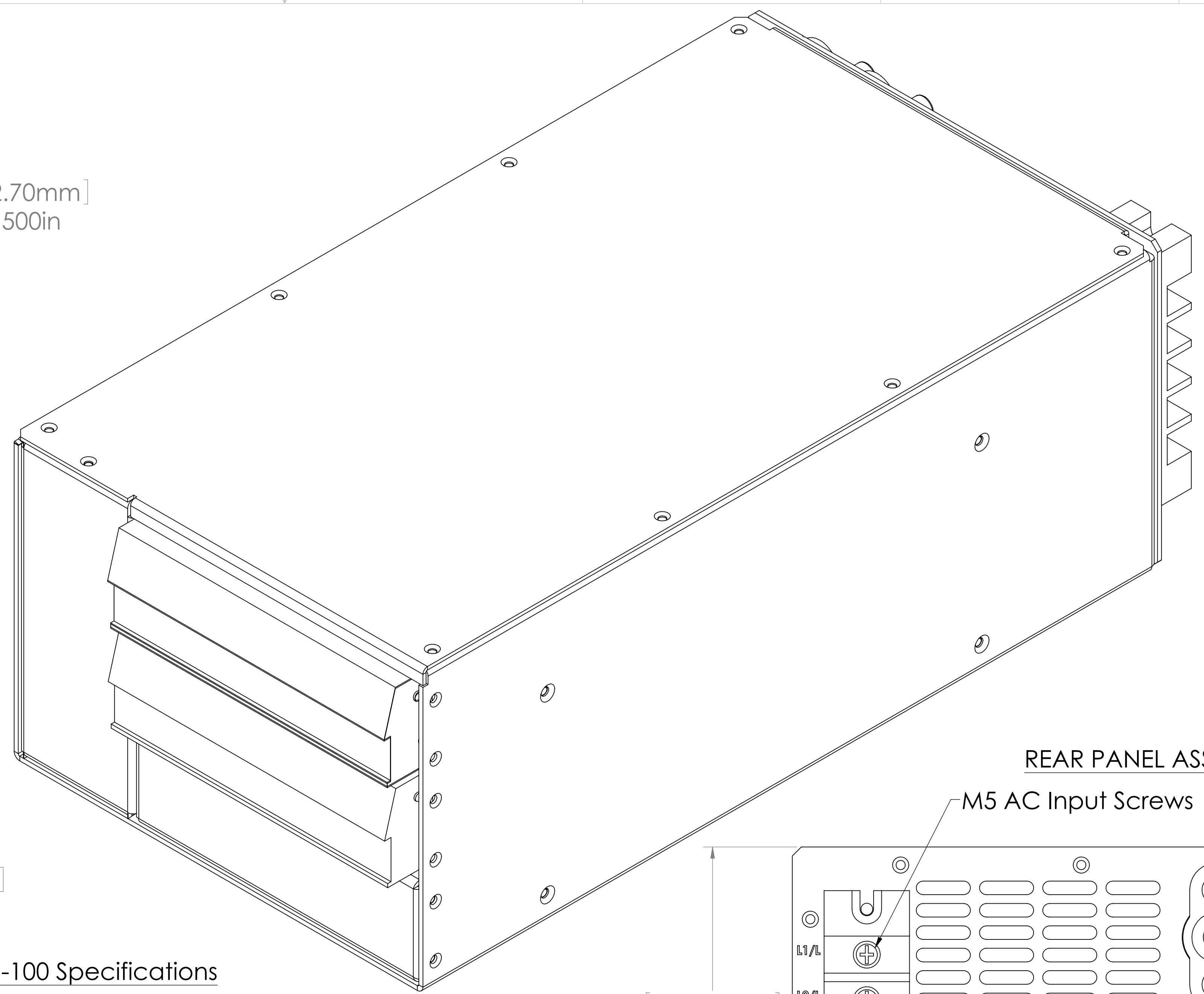

REAR PANEL ASSY.

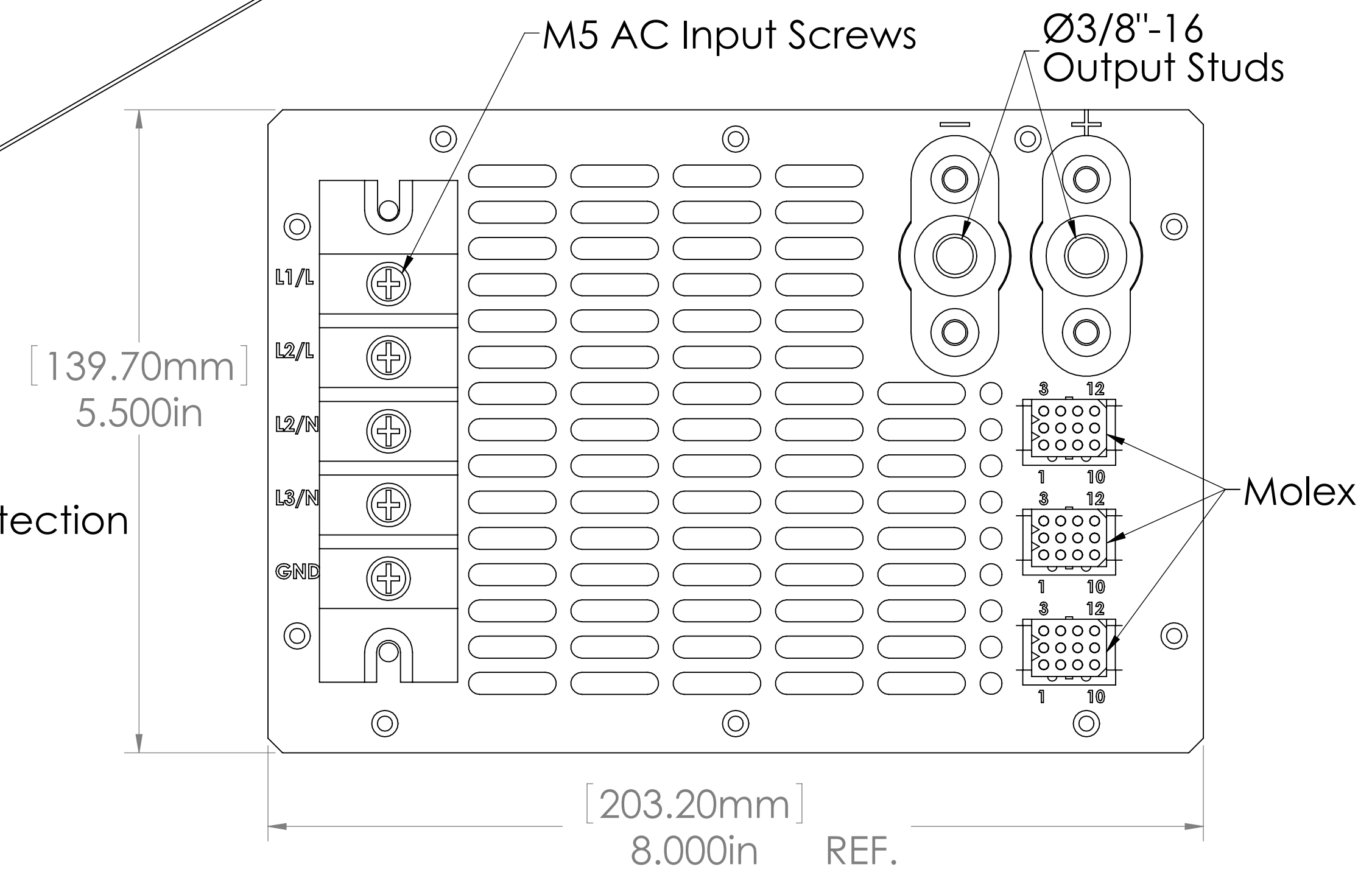

DC-100 Specifications

- 30V / 93.8A - 3000W
- Single or Three Phase AC Input
- 85-264 VAC Input
- 0-50°C 100 Load (0-70°C 50% Load)
- Over Temperature, Over Voltage and Over Current Protection
- Status LEDs: AC-OK, DC-OK and Over Temperature Fail
- Remote Voltage Sense Lines
- Remote Inhibit and Status Signals
- Inrush Current Limiting NTCs
- 2 FXP1500-32S202G Power Supplies

| CONTROL SIGNAL PIN OUT | |
|------------------------|--------------------------|
| MOLEX PIN | SIGNAL |
| 1 | V Sense + |
| 2 | n.c. |
| 3 | DC Fail |
| 4 | V Sense - & Logic Ground |
| 5 | AC Fail |
| 6 | Over Temp |
| 7 | Aux +5V |
| 8 | n.c. |
| 9 | n.c. |
| 10 | Aux GND |
| 11 | Output Inhibit |
| 12 | n.c. |

PROPRIETARY AND CONFIDENTIAL NOTICE:
THE DESIGN AND RELATED INFORMATION CONTAINED HEREIN AND/OR ATTACHED IS THE SOLE PROPERTY OF ARROW ELECTRONICS. THE DISCLOSURE OF THIS INFORMATION DOES NOT CONSTITUTE THE RELEASE OF ANY PROPRIETARY RIGHTS THEREIN. PERMISSION TO REPRODUCE THIS INFORMATION OR THE PRODUCTS DISCLOSED HEREIN AND/OR ATTACHED MUST BE OBTAINED IN WRITING FROM ARROW ELECTRONICS.

| | | | |
|---|------------------------|-------------------|--|
| UNLESS OTHERWISE SPECIFIED: DO NOT SCALE DRAWING DIMENSIONS ARE IN INCHES TOLERANCES: FRACTIONAL: ±1/64 ANGULAR: ±.5 BEND ±.015 .XX ±.01 .XXX ±.005 | NAME | DATE | ARROW ELECTRONICS, INC. |
| | V.NGUYEN | 8/2/10 | |
| INTERPRET GEOMETRIC TOLERANCING PER: ASME Y14.5M-1994 | CHECKED | - | TITLE: DC-100 30V @ 93.8A, 3000W SYNRAD SYSTEMS |
| | ENGR | - | |
| MATERIAL SEE BOM | MFG | - | SIZE DWG. NO. REV D VAD611132 A |
| | Q.A. | - | |
| FINISH SEE BOM | THIRD ANGLE PROJECTION | WEIGHT: 0.358 LB. | SCALE: 4:1 SHEET 1 OF 1 |

PS-100 12-Pin Molex Connector Pin Out

| Pin # | Signal Name | Description | Vmax Imax | Normal Operation | Fault Condition |
|-------|--|--|--------------------|-------------------------|-------------------------|
| 1 | V Sense + input ¹ | Leave open or connect to V+ at the load. | dV <3 Vpp 30 mA | n/a | n/a |
| 2 | n.c. | | | | |
| 3 | DC Fail output ² | | 15 V 20 mA | Low State (<0.4 V) | High State (Pull Up) |
| 4 | V Sense – input ³ / Logic Ground | Leave open or connect to V– at the load / Logic Ground (return) for DC Fail, AC Fail, and Over Temp outputs. | dV <3 Vpp 30 mA | n/a | n/a |
| 5 | AC Fail output ² | | 15 V 20 mA | Low State (<0.4 V) | High State (Pull Up) |
| 6 | Over Temp output ⁴ | | 15 V 20 mA | High State (Pull Up) | Low State (<0.4 V) |
| 7 | Aux +5V output | Isolated +5V output. Reference to Pin 10, Aux Ground. | | n/a | n/a |
| 8 | n.c. | | | | |
| 9 | n.c. | | | | |
| 10 | Aux Ground | Isolated Aux Ground (return) for Aux +5V output. | | n/a | n/a |
| 11 | Output Inhibit input ⁵ | DC output enabled when open or pulled Low. Connect this input to Pin 7, Aux +5V, to inhibit DC output. | 10 V 3.5 mA | n/a | n/a |
| 12 | n.c. | | | | |

Connection Notes:

Each of the two power supply modules has its own I/O connector.

- This pin is internally connected to V+ through 100 Ohm resistor. For remote sensing, connect Pin 1 (V sense +) on connector 1 to Pin 1 on connector 2 and then connect to positive (+) side at load.
- Module-specific output. Open-Collector output protected by 16 V Zener diode and 10 Ohm resistor in series. These output signals are pulled Low during normal operation and are floating during a fault condition. Use a user-supplied external 500 Ohm resistor to pull High to 5V level for fault annunciation. Output rated for 15 V, 20 mA maximum.
- Pin 4 (V sense – signal) is internally connected to V– through 100 Ohm resistor. For remote sensing, connect Pin 4 (V sense –) on connector 1 to Pin 4 on connector 2 and then connect to negative (–) side at load.
- Module-specific output. Open-Collector output protected by 16 V Zener diode and 10 Ohm resistor in series. This output signal is floating during normal operation and pulled Low during a fault condition. Use a user-supplied external 500 Ohm resistor to pull Low from 5V level for fault annunciation. Output rated for 15 V, 20 mA maximum.
- Module-specific input. DC output enabled when input open or pulled Low (<0.8 V). Connect this input to Pin 7, Aux +5V, to inhibit DC output (> 2.0 V). 2.5 mA of current will pull input High and disable DC output.

The mating connector for the 12-pin Molex connector is Amp #556879-4. The required contact pins are Amp #556880-2.



Applications

- Test & measurement, RF amplifiers & transmitters, factory automation, semiconductor & LD-MOS based equipment, and other distributed power applications

Features

- 28 VDC, 32 VDC and 36VDC output voltage preset via VID pins
- Margining via I²C
- Active current/load sharing
- Wide input voltage range 85-264 VAC
- Highly-efficient topology yields 89% at 230 VAC
- 1U high: 5.6" x 1.6" x 12" cassette
- Input fuse protected
- I²C interface status and control
- High density design: 13.4 W/in³
- Up to 4500 W in a 1U-high, 19-inch wide rack
- Standby voltage 5 VDC/1A
- Adjustable output voltage
- Overtemperature, output overvoltage, and output overcurrent protection
- ORing circuit for true redundant operation
- Status LEDs: AC OK, DC OK, Fan Fail/Overtemperature Fail
- Auto select power limits ¹



The FXR-3-32G shelf provides capability to parallel up to three FXP1500-32G PSUs in a 19" rack, see rack section (below) for power shelf details.

Description

The FXP1500-32G is a 1500 watt, power factor corrected (PFC) front-end, which provides a user-adjustable 32 VDC (26-38 VDC range) main output for test & measurement, RF amplifiers and transmitters, factory automation, semiconductor equipment, and other distributed power applications. The FXP1500-32G provides for true hot-swap with AC and DC connections at the rear of the model and can be used for redundant system applications. Its very small dimensions allow configuration of up to three units in a 1U rack (up to 4500 W). The highly-efficient thermal design with internal fan cooling permits its use in wide operating voltage and temperature ranges to provide very high reliability.

Status information is provided with front panel LEDs, logic signals, and via the I²C management interface. In addition, the I²C bus can enable the power supply, control the fan speed, adjust the output voltage, and set the output current limit.

The FXP1500-32G meets international safety standards and displays the CE-Mark for the European Low Voltage Directive (LVD).

Model Selection

| Model | Input voltage VAC auto selected ¹ | Output 1 | | Output 2 | | Rated power W |
|-------------|--|---------------------------|---------------------------|---------------------------|---------------------------|-------------------|
| | | V _{o nom} VDC | I _{o max} ADC | V _{o nom} VDC | I _{o max} ADC | |
| FXP1500-32G | 85 – 264 | 32 | 46.9 | 5 | 1 | 1505 ³ |

¹ The available output power is automatically adjusted depending on the input voltage.

² 1U standard rack FXR-3-32G for FXP1500-32G is available from Power-One.

³ Automatic derating of main output below 108 VAC to: I_{o max} = 37.5 A (1200 W).

Absolute Maximum Ratings

Stress in excess of the absolute maximum ratings may cause performance degradation, adversely effect long-term reliability, or cause permanent damage to the converter.

| Parameter | Conditions/description | Min | Max | Unit |
|-------------------------------|---|-----|------------|------------|
| Input voltage | Continuous Transient, 60 ms max. | | 264 300 | VAC VAC |
| Operating ambient temperature | V _{i min} -V _{i max} , I _{o nom} , cooling by internal fan 100 % load from 0 to 50°C linear derating to 50% load from 50°C to 70°C | 0 | 70 | °C °C |
| Storage temperature | Non-Operating | -40 | 85 | °C |

Environmental, Mechanical, & Reliability Specifications

| Parameter | Conditions/description | Min | Nom | Max | Unit |
|-----------------------------------|---|-----|------|--------------|--------------------|
| Altitude | Operating Non-Operating | | | 10 k 40 k | ASL Ft. ASL Ft. |
| Relative humidity, non-condensing | Operating | 10 | | 90 | % RH |
| | Storage | 5 | | 95 | % RH |
| Temperature coefficient | 0 °C to 70 °C (after 15 min warm-up) | | | 0.02 | %/K |
| Shock | IEC/EN 60068-2-27, 11 ms | | | 40 | g _{pk} |
| Sinusoidal vibration | IEC/EN 60068-2-6 2-8 Hz 8-200 Hz 200-500 Hz | | 7.5 | | mil |
| | | | 2 | | g _{pk} |
| | | | 4 | | g _{pk} |
| Random vibration | 10-2000 Hz | | 6.15 | | g _{rms} |
| MTBF | Calculated per Bellcore (SR-332, Issue 1): GB 25°C | 230 | | | kh |
| | Demonstrated | 250 | | | kh |

Safety Specifications

Maximum electric strength testing is performed in the factory according to EN 550116, IEC/EN 60950, and UL 60950. Input-to-output electric strength tests should not be repeated in the field. Power-One will not honor any warranty claims resulting from electric strength field tests.

| Parameter | Conditions/description | Min | Nom | Max | Unit |
|--------------------------------|--|---|-----|-----|------------------------------|
| Agency approvals | UL60950, (UL) CSA 60950 (cUL), EN 60950(TÜV), CE Mark for LVD | | | | |
| Insulation safety rating | Input to case Input to output Output to case | Basic Reinforced Functional | | | |
| Electric strength test voltage | Input to case Input to output Output to case Output 1 to output 2 | 2.12 Note ¹ 0.1 0.1 | | | kVDC kVDC kVDC kVDC |

¹ Subassemblies are pre-tested with 4.2 kVDC in accordance with EN50116 and IEC/EN60950.

EMC Specification

| Parameter | Description | Criterion |
|----------------------------------|---|--|
| Electrostatic discharge | IEC/EN 61000-4-2, level 4 (contact/air) | 8/15 kV, Performance criterion B |
| Electromagnetic field | IEC/EN 61000-4-3, level 3 | 10 V/m, Performance criterion A |
| Electrical fast transients/burst | IEC/EN 61000-4-4, level 3 (L/L, L/E) | 2 / 1 kV, Performance criterion B |
| Surge | IEC/EN 61000-4-5, level 3 (L/L, L/E) | 1 / 2 kV, Performance criterion B |
| Voltage dips and interruptions | IEC/EN 61000-4-11 Dip 30 %, 100 ms Dip 30 %, 200 ms Dip 60 %, 20 ms Dip 60 %, 100 ms Dip > 95 %, 20 ms Dip > 95 %, 100 ms | Performance criterion A Performance criterion B Performance criterion A Performance criterion B Performance criterion A Performance criterion B |
| RF conducted immunity | IEC/EN 61000-4-6 | 10 VAC, AM 80 %, 1 kHz Performance criterion A |
| Emissions conducted | CISPR 22/EN 55022/EN 61204 | Class B |
| Emissions radiated | CISPR 22/EN 55022/EN 61204 | Class A |
| Harmonics | IEC/EN 61000-3-2 | Class B |
| Voltage fluctuation and flicker | IEC/EN 61000-3-3 | Pass |
| Voltage sag | SEMI F47-0200 (High Line 230V) | Pass |

Input Specification

Specification is valid for input voltage, load, and temperature ranges, unless otherwise stated.

| Parameter | Conditions/description | Min | Nom | Max | Unit |
|---------------------------|--|------|-------|-----|------------------|
| Input voltage | | 85 | 230 | 264 | VAC |
| Input frequency | | 47 | 50/60 | 63 | Hz |
| Turn-on input voltage | Ramping up | 79 | - | 85 | VAC |
| Turn-off input voltage | Ramping down | 70 | - | 78 | VAC |
| Inrush current limitation | 115/230 VAC acc. ETS 300 132-1 < 100 ms | | | 50 | A _{pk} |
| Hold-up time | After last AC line peak, V _i = 230 VAC, P _{o nom} | 20 | | | ms |
| Power factor | V _{i nom} , I _{o nom} | 0.95 | | | W/VA |
| Efficiency | V _i = 230 VAC, V _{o nom} , I _{o nom} , T _c =25°C | 89 | 89.5 | | % |
| Max input current | | | | 20 | A _{rms} |

Output Specification

Specification is valid for input voltage, load, and temperature ranges, unless otherwise stated.

| Parameter | Conditions/Description | Min | Nom | Max | Units |
|--|---|---------------|--|-----------------------|--|
| Total output voltage range | Adjustable via T4, T5 pins & I ² C | 26 | | 38 | VDC |
| Output voltage set point | Adjustable via T4, T5 pins (LL=28V, LH=HL=32V, HH=36V) | | 28 32 36 | | VDC VDC VDC |
| Output voltage trimming | Adjustable via I ² C from any set point. Note: all changes to V _{o1} made via I ² C are volatile and are lost upon power cycling the PSU | -2 | | +2 | VDC |
| Overvoltage protection latching | 28V set point 32V set point 36V set point | | 35 40 45 | | VDC VDC VDC |
| Nominal current output 1 | I _{o1 nom} @ V _i = 105 VAC – 264 VAC, P _o 1.5 kW 28V set point 32V set point 36V set point I _{o1 nom} @ V _i = 85 VAC – 105 VAC, P _o 1.2 kW 28V set point 32V set point 36V set point | | 46.9 46.9 41.7 42.9 37.5 33.4 | | ADC ADC ADC ADC ADC ADC |
| Nominal current output 2 | I _{o2 nom} @ V _i = 85 VAC – 265 VAC, P _o 5 W | | 1.0 | | ADC |
| Current limit output 1 | I _{o1 max} @ V _i = 105 VAC – 264 VAC high droop hic-cup I _{o1 max} @ V _i = 85 VAC – 105 VAC high droop hic-cup | | 48.8 50.8 39.0 41.0 | | ADC ADC ADC ADC |
| Current limit output 2 | I _{o2 max} @ V _i = 85 VAC – 265 VAC | | 1.3 | | ADC |
| Static line regulation output 1 | V _{i min} - V _{i max} , 50 % I _{o nom} | -0.5 | | 0.5 | % V _{o nom} |
| Static load regulation output 1 (droop characteristic) | V _i = 230 V, 0-100 % I _{o nom} V _o : full load (46.9 ADC) to no load | 31.68 -1.0 | 32 | 13.6 32.32 +1.0 | mV/A VDC % V _{o nom} |
| Dynamic load regulation | Load change 1% ↔ 100% I _{o nom} , dI _o /dt = 1 A/μs Voltage deviation (droop + over- or undershoot) Max. recovery time to within 1 % of V _{o1 nom} | -4 | | +4 2000 | % V _{o nom} μs |
| Start-up time | Time required for output within regulation after initial application of AC-input (V _{i nom} , I _{o nom}) after removal of inhibit (V _{i nom} , I _{o nom}) | | 100 | 1.5 | s ms |
| Output voltage ripple and noise | V _{i nom} , I _{o nom} , 20 MHz bandwidth V _{o1} V _{o2} | | | 320 50 | mV _{pp} mV _{pp} |
| Remote sense | Total compensation for cable losses | | | 500 | mV |
| Active current share | Difference in current between two units for V _{o1} above 10 % load. Active current share pin with its 1kΩ internal impedance enables control of output voltage. Voltage on this pin is proportional to output current, 2V at I _{o1 nom} | | | 5 | ADC |

Controls and Indicators

Specification is valid for input voltage, load, and temperature ranges, unless otherwise stated.

| Parameter | Type ¹ | Conditions/Description |
|---|---------------------------|---|
| Visual Status Indication | FP | LED indicators ² : <ul style="list-style-type: none"> • DC OK (green) • AC OK (green) • Fan fail & Over-temperature (amber) |
| I ² C communication bus | OC[S1, S2] | <ul style="list-style-type: none"> • Monitors alarm functions and allows control of specific parameters. • Uses standard Philips two wire bus (SCL and SDA signal lines) |
| I ² C communication bus addressing | OC[T1-T3] | Three lines provide up to 8 separate PSU I ² C addresses |
| PS present pin | OC[U3] | <ul style="list-style-type: none"> • Used by system to indicate a PSU is installed in a system shelf • Contact closure to logic ground (internal pull-down resistor of 1 kΩ) |
| PS main output remote shutdown | OC[R1] | <ul style="list-style-type: none"> • TTL compatible signal, inhibited when open contact, high or at TTL logic "1" • Signal referenced to logic return (LRTN) |
| | FP | Two position switch in series with OC signal (logical AND) allows local enable/disable; "0" Position => PS disabled; "1" Position => PS Enabled |
| Power supply OK | I ² C | AC OK & DC OK & no overcurrent & no over-temperature & fans working |
| DC current fail | I ² C | Reports over-current condition on main output, I _{O1} |
| AC fail / Power down warning | OC[U2] & I ² C | <p>Provides a warning that the input power has failed at least 5 ms before the output falls out of regulation (<90% V_{O1} set).</p> <ul style="list-style-type: none"> • Open collector signal with 20 mA pull-down capability, referenced to logic return (LRTN). • AC fail will go high or open during power fail condition and will go low when input is within the operating range. • A Power Fail warning will turn off the front panel green AC OK LED. |
| DC fail / Output voltage fault | OC[U4] & I ² C | <p>Internal under-voltage and overvoltage supervision of V_{O1}.</p> <ul style="list-style-type: none"> • Open collector signal with 20 mA pull-down capability, referenced to logic return (LRTN). • DC fail will go high or open if Vo1 < 90% or V_{O1}> 110% of V_{O1} set, measured in front of the ORING FETs. • Green LED on the front panel indicates normal operation; LED will flash if in parallel operation V_{O1} is OK, but the unit is disabled. |
| Critical temperature Warning/Fan Fail | OC[U1] & I ² C | <p>Indicates the PSU operating temperature has reached [T_{shut-down} – 10K] Indicates if the unit is in over-temperature shutdown.</p> <ul style="list-style-type: none"> • Open collector signal with 20 mA pull-down capability, referenced to logic return (LRTN). • The OC-output will go low 100 ms before an over-temperature condition shuts down the unit. • An amber LED on the front panel indicates over-temperature or fan fail. |
| DC voltage monitoring | I ² C | Monitors the main output voltage, V _{O1} , seen at the output connector Accuracy is ±1% over setting range and temperature. |
| DC current monitoring | I ² C | Monitors the output current I _{O1} : Accuracy ± 1% over the load range. |
| Active current share interconnect | OC[R4] | Line must be connected to all paralleled PSUs to allow active current share functionality between units |
| V _{O1} presets | OC[T4,T5] | <p>Output voltage is preset per programming of T4, T5</p> <ul style="list-style-type: none"> • T4/T5 = LOW / LOW => V_{O1}=28VDC • T4/T5 = LOW / HIGH = HIGH / LOW => V_{O1}=32VDC • T4/T5 = HIGH / HIGH => V_{O1}=36VDC |
| V _{O1} voltage trimming (margining) | I ² C | <p>Output voltage trimming Vo1: ±2 VDC</p> <p>Setting accuracy over I²C: ± 50mV at V_{O1}nom, ± 150 mV over setting range</p> |
| Fan speed control | I ² C | Two fan speed levels automatically set depending on the internal temperature. The fan speed can be set to full speed or automatic control via I ² C command. |
| Fan OK/FAIL | OC[U1] & I ² C | Indicates if the cooling fans are operating or have failed. |
| Synchronized startup pin | OC[R5] | Overcurrent signal which can be used for synchronous startup of units in parallel or to recover from an overload condition. |

¹ Abbreviations used:

- **OC[#]** => Hardwired signal accessible at PSU output connector, with pin number reference
- **FP** => Provided by devices located on PSU Front panel
- **I²C** => Signal provided over I²C communication system; detailed I²C information is available from the specific model's I²C Manual found on the Power-One web site.

² See LED Function table for further details

Output Connector Pinning and Signal Specification

| Output Connector Description | OC Pin # | Type | Signal Reference | Low level High level | V max I max |
|---|------------|--|--|---------------------------|-------------------------------|
| Over-temperature / Fan Fail | U1 | OC-output, protected by 16 V Zener diode and a 10Ω resistor in series | LGND | <0.4 V @ 20 mA Pull up | 15 V 20 mA |
| AC Fail / Power down warning | U2 | | | <0.4 V @ 20 mA Pull up | 15 V 20 mA |
| Power Supply Present | U3 | 1KΩ Resistor connected to logic GND | LGND | Open Pull up | 10 V 10 mA |
| DC Fail / Output voltage fault | U4 | OC-output, protected by 16 V Zener diode and a 10Ω resistor in series | LGND | <0.4V @ 20 mA Pull up | 15 V 20 mA |
| Internal ground (INT GND) | U5 | Used only for ADDR _x and V _{O1} set. Do not connect the internal grounds in systems with several units. | Connected to V _{O1} - line before the output filter | - | - |
| ADDR0 I ² C address bus | T1 | High = internal 10 KΩ PU to 5V=> Logic 1 Low = connect to INT GND => Logic 0 | INT GND | Logic 1 Logic 0 | 5V 0V |
| ADDR1 I ² C address bus | T2 | | | | |
| ADDR2 I ² C address bus | T3 | | | | |
| V _{O1} set | T4 | | | | |
| V _{O1} set | T5 | | | | |
| SDA, I ² C serial data line | S1 | I ² C compatible signal referenced to logic GND 5 V or 3.3 V logic | LGND | Logic 1 Logic 0 | 5V 0V |
| SCL, I ² C serial clock line | S2 | | | | |
| Auxiliary power +5 V | S3 | V _{O2+} output, isolated from main output | Aux output is floating | - | - |
| Auxiliary power +5 VRTN | S4 | Aux output return; ground isolated from main output | | | |
| Logic ground (LGND) | S5 | Internally connected to Aux GND through 10Ω resistor. Wire LGND separately from Aux RTN and main output GND to minimize noise on signals and I ² C bus. Leave open if not used. | - | - | - |
| Output inhibit R1 | R1 | PS active when pulled low (DC-DC stage off when left open) | LGND | <0.8 V >2.0 V | 10 V 3.5 mA |
| V sense + | R2 | Open or connected to V _{O1+} at the load Internally connected to V _{O1+} via 100 Ω. | - | - | dV<3 V _{pp} 30 mA |
| V sense - | R3 | Open or connected to V _{O1-} at the load Internally connected to V _{O1-} via 100 Ω. | - | - | |
| Active Current Share | R4 | This pin must be interconnected to pin R4 of all other paralleled PSUs for proper operation of active current share function | - | - | 2V |
| Synchronized Startup (for paralleled units) | R5 | Open or connected to synch startup circuit | V _{O1} - at the OC | | 12V 2mA |
| V _{O1-} | P1, P3, P5 | Main output - pins | - | - | - |
| V _{O1+} | P2, P4, P6 | Main output + pins | - | - | - |
| Input Connector Description | OC Pin # | Type | | | |
| Protection Earth | P1 | PE | | | |
| Phase | P2 | L | | | |
| Neutral | P3 | N | | | |

Protection

| Parameter | Conditions/description | Min | Nom | Max | Unit |
|--|-----------------------------------|--|-----|-----|------|
| Input fuse | Not user accessible | 25AF | | | |
| Inrush current limitation | | with NTCs | | | |
| Output | | No-load, short circuit, and overload proof | | | |
| Overvoltage protection latching ¹ | Absolute | | 40 | | V |
| Over-temperature protection | Automatic power shutdown at T_C | | 95 | | °C |

LED Indicator Functionality

| Condition | Power Fail (AC OK) | Output Good (DC OK) | Fan Fail and Over - Temperature |
|---------------------------------------|--------------------|---------------------|---------------------------------|
| Normal Operation | Green | Green | OFF |
| Power Supply is inhibited | Green | OFF | Amber |
| Input AC is low | OFF | OFF | Amber |
| Input AC is low or missing | OFF | OFF | Amber/OFF |
| Over-temperature | Green | OFF | Amber |
| Output overload (In regulation) | Green | Green | OFF |
| Output Overloaded (Out of Regulation) | Green | OFF | OFF |
| Fan Not running | Green | OFF | Amber |
| Power Supply Failed | OFF | OFF | OFF/ Amber |

Cooling:

To achieve best cooling results sufficient airflow through the unit must be ensured. Do not block or obstruct the airflow at the rear of the unit by placing large components directly at the output connector.



Mechanical Data

| | |
|---------------------------|--|
| Mechanical Data (W, H, D) | 5.6" (141.2mm) x 1.6" (40.5mm) x 12" (304.8mm) |
|---------------------------|--|

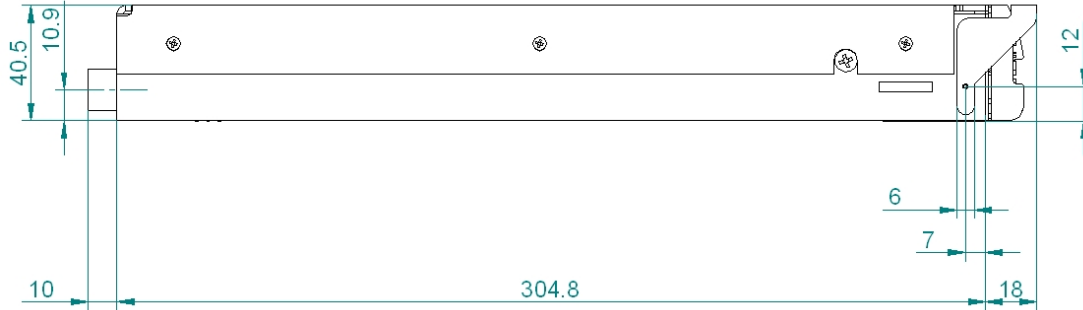

Output Connector FCI part no. 51732-020LF

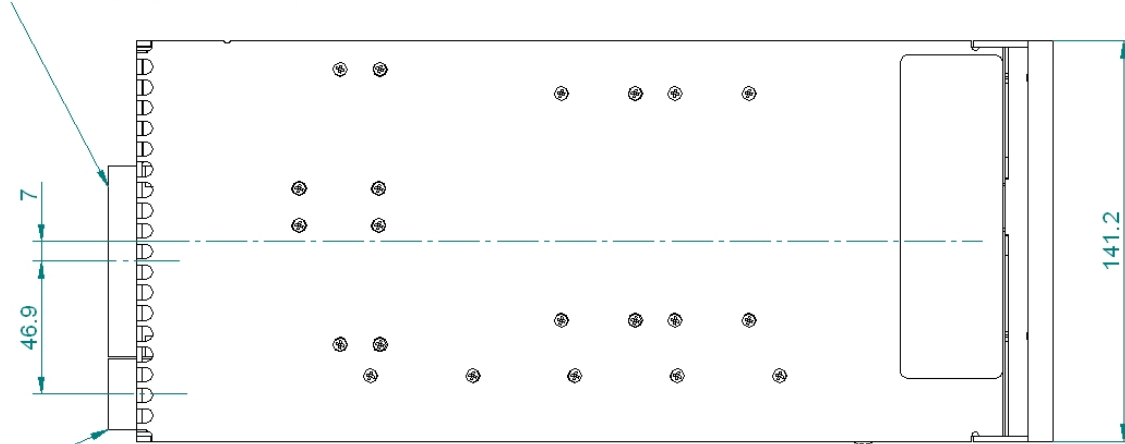

Input Connector FCI part no. 51939-126LF

Input and Output Connector Descriptions

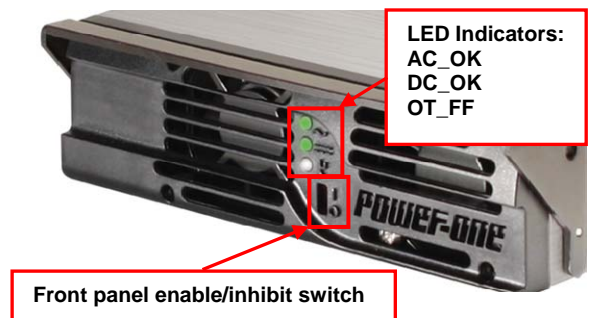
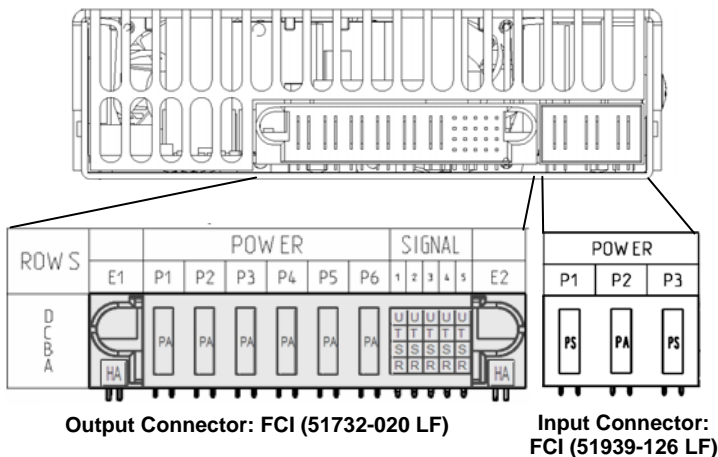

FXP series front bezel showing LED indicators and recessed enable switch

Female ledge connector: Manufacturer: FCI
 Output connector Part No.: 51762-10602000AA LF (Horizontal)
 Output connector Part No.: 51742-10602000AA LF (Vertical)
 Input connector Part No.: 51915-056LF (Horizontal)
 Input connector Part No.: 51940-099LF (Vertical)
 Information on availability under <http://www.stkcheck.com/evs/fcielectronics/fcisearch.asp>